

marantz®

Model PM-11S2 User Guide

Integrated Amplifier

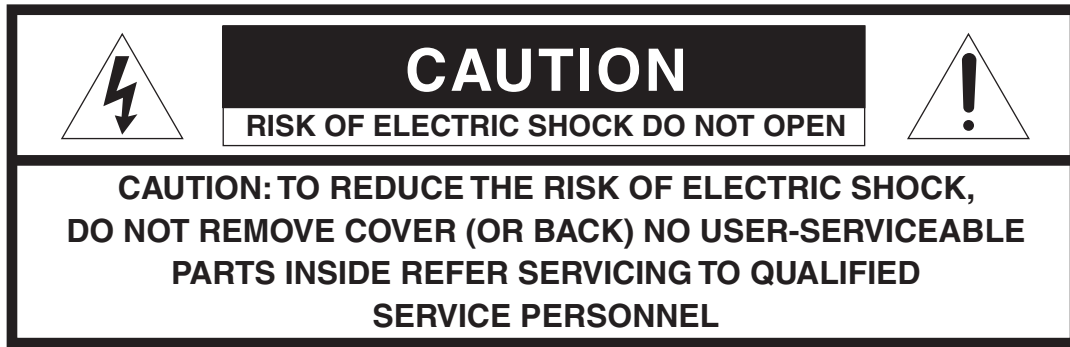

The lightning flash with arrowhead symbol within an equilateral triangle is intended to alert the user to the presence of uninsulated “dangerous voltage” within the product’s enclosure that may be of sufficient magnitude to constitute a risk of electric shock to persons.



The exclamation point within an equilateral triangle is intended to alert the user to the presence of important operating and maintenance (servicing) instructions in the literature accompanying the product.

WARNING

TO REDUCE THE RISK OF FIRE OR ELECTRIC SHOCK, DO NOT EXPOSE THIS APPLIANCE TO RAIN OR MOISTURE.

CAUTION: TO PREVENT ELECTRIC SHOCK, MATCH WIDE BLADE OF PLUG TO WIDE SLOT, FULLY INSERT.

ATTENTION: POUR EVITER LES CHOCS ELECTRIQUES, INTRODUIRE LA LAME LA PLUS LARGE DE LA FICHE DANS LA BORNE CORRESPONDANTE DE LA PRISE ET POUSSER JUSQU’AU FOND.

IMPORTANT SAFETY INSTRUCTIONS

READ BEFORE OPERATING EQUIPMENT

This product was designed and manufactured to meet strict quality and safety standards.

There are, however, some installation and operation precautions which you should be particularly aware of.

1. Read these instructions.
2. Keep these instructions.
3. Heed all warnings.
4. Follow all instructions.
5. Do not use this apparatus near water.
6. Clean only with dry cloth.
7. Do not block any ventilation openings. Install in accordance with the manufacture's instructions.
8. Do not install near any heat sources such as radiators, heat registers, stoves, or other apparatus (including amplifiers) that produce heat.
9. Do not defeat the safety purpose of the polarized or grounding-type plug. A polarized plug has two blades with one wider than the other. A grounding type plug has two blades and a third grounding prong. The wide blade or the third prong are provided for your safety. If the provided plug does not fit into your outlet, consult an electrician for replacement of the obsolete outlet.
10. Protect the power cord from being walked on or pinched particularly at plugs, convenience receptacles, and the point where they exit from the apparatus.
11. Only use attachments/accessories specified by the manufacturer.
12. Use only with the cart, stand, tripod, bracket, or table specified by the manufacturer, or sold with the apparatus. When a cart is used, use caution when moving the cart/apparatus combination to avoid injury from tip-over.



13. Unplug this apparatus during lightning storms or when unused for long periods of time.
14. Refer all servicing to qualified service personnel. Servicing is required when the apparatus has been damaged in any way, such as power-supply cord or plug is damaged, liquid has been spilled or objects have fallen into the apparatus, the apparatus has been exposed to rain or moisture, does not operate normally, or has been dropped.

Additional Safety Information!

- This product should not be placed in a built-in installation such as a bookcase or rack unless proper ventilation is provided or the manufacturer's instructions have been adhered to.
- Apparatus shall not be exposed to dripping or splashing and that no objects filled with liquids, such as vases, shall be placed on the apparatus.
- When the switch is in the OFF position, the apparatus isn't completely switched-off from the MAINS.
- The equipment shall be installed near the power supply so that the power supply is easily accessible.
- Do not touch hot areas, especially around the "hot surface mark" during and immediately after use.
- During and immediately after use, this product is hot in areas other than the controls and rear panel connection jacks. Do not touch hot areas, especially around the "hot surface mark" and the top panel. Contact with hot areas can cause burns.



Hot surface mark

- Do not expose the unit and batteries to excessive heat such as direct sunlight, fire or the like.
- Make a space of about 8 inches (0.2 m) around the unit.

ENGLISH

WARRANTY

For warranty information, contact your local Marantz distributor.

RETAIN YOUR PURCHASE RECEIPT

Your purchase receipt is your permanent record of a valuable purchase. It should be kept in a safe place to be referred to as necessary for insurance purposes or when corresponding with Marantz.

IMPORTANT

When seeking warranty service, it is the responsibility of the consumer to establish proof and date of purchase. Your purchase receipt or invoice is adequate for such proof.

FOR U.K. ONLY

This undertaking is in addition to a consumer's statutory rights and does not affect those rights in any way.

FRANÇAIS

GARANTIE

Pour des informations sur la garantie, contacter le distributeur local Marantz.

CONSERVER L'ATTESTATION D'ACHAT

L'attestation d'achat est la preuve permanente d'un achat de valeur. La conserver en lieu sûr pour s'y reporter aux fins d'obtention d'une couverture d'assurance ou dans le cadre de correspondances avec Marantz.

IMPORTANT

Pour l'obtention d'un service couvert par la garantie, il incombe au client d'établir la preuve de l'achat et d'en corroborer la date. Le reçu ou la facture constituent des preuves suffisantes.

DEUTSCH

GARANTIE

Bei Garantiefragen wenden Sie sich bitte an Ihren Marantz-Händler.

HEBEN SIE IHRE QUITTING GUT AUF

Die Quittung dient Ihnen als bleibende Unterlage für Ihren wertvollen Einkauf. Das Aufbewahren der Quittung ist wichtig, da die darin enthaltenen Angaben für Versicherungszwecke oder bei Korrespondenz mit Marantz angeführt werden müssen.

WICHTIG!

Bei Garantiefragen muß der Kunde eine Kaufunterlage mit Kaufdatum vorlegen. Ihren Quittung oder Rechnung ist als Unterlage ausreichend.

NEDERLANDS

GARANTIE

Voor inlichtingen omtrent garantie dient u zich tot uw plaatselijke Marantz.

UW KWITANTIE, KASSABON E.D. BEWAREN

Uw kwitantie, kassabon e.d. vormen uw bewijs van aankoop van een waardevol artikel en dienen op een veilige plaats bewaard te worden voor evt. verwijzing bijv. in verband met verzekering of bij correspondentie met Marantz.

BELANGRIJK

Bij een evt. beroep op de garantie is het de verantwoordelijkheid van de consument een gedateerd bewijs van aankoop te tonen. Uw kassabon of factuur zijn voldoende bewijs.

ITALIANO

GARANZIA

L'apparecchio è coperto da una garanzia di buon funzionamento della durata di un anno, o del periodo previsto dalla legge, a partire dalla data di acquisto comprovata da un documento attestante il nominativo del Rivenditore e la data di vendita. La garanzia sarà prestata con la sostituzione o la riparazione gratuita delle parti difettose.

Non sono coperti da garanzia difetti derivanti da uso improprio, errata installazione, manutenzione effettuata da personale non autorizzato o, comunque, da circostanze che non possano riferirsi a difetti di funzionamento dell'apparecchio. Sono inoltre esclusi dalla garanzia gli interventi inerenti l'installazione e l'allacciamento agli impianti di alimentazione.

Gli apparecchi verranno riparati presso i nostri Centri di Assistenza Autorizzati. Le spese ed i rischi di trasporto sono a carico del cliente.

La casa costruttrice declina ogni responsabilità per danni diretti o indiretti provocati dalla inosservanza delle prescrizioni di installazione, uso e manutenzione dettagliate nel presente manuale o per guasti dovuti ad uso continuato a fini professionali.

CE MARKING

CE English

The PM-11S2 is in conformity with the EMC directive and low-voltage directive.

CE Français

Le PM-11S2 est conforme à la directive EMC et à la directive sur les basses tensions.

CE Deutsch

Das Modell PM-11S2 entspricht den EMC-Richtlinien und den Richtlinien für Niederspannungsgeräte.

CE Nederlands

De PM-11S2 voldoet aan de EMC eisen en de vereisten voor laag-voltage.

CE Italiano

Il PM-11S2 è conforme alle direttive CEE ed a quelle per i bassi voltaggi.

English

WARNINGS

- Do not expose the equipment to rain, moisture, dripping or splashing.
- Do not remove the cover from the equipment.
- Do not insert anything into the equipment through the ventilation holes.
- Do not handle the mains cord with wet hands.
- Do not cover the ventilation with any items such as tablecloths, newspapers, curtains, etc.
- No naked flame sources, such as lighted candles, should be placed on the equipment.
- When disposing of used batteries, please comply with governmental regulations or environmental public instruction's rules that apply in your country or area.
- Make a space of about 0.2 meter around the unit.
- No objects filled with liquids, such as vases, shall be placed on the equipment.
- When the switch is in the OFF position, the equipment is not completely switched off from MAINS.
- The equipment shall be installed near the power supply so that the power supply is easily accessible.
- Do not touch hot areas, especially around the "hot surface mark" during and immediately after use.
- During and immediately after use, this product is hot in areas other than the controls and rear panel connection jacks. Do not touch hot areas, especially around the "hot surface mark" and the top panel. Contact with hot areas can cause burns.



Hot surface mark

- Do not expose the unit and batteries to excessive heat such as direct sunlight, fire or the like.

Français

AVERTISSEMENTS

- Ne pas exposer l'appareil à la pluie, à l'humidité, à l'égouttement ou aux éclaboussures.
- Ne pas essayer de retirer le boîtier de l'appareil.
- Ne rien insérer dans l'appareil par les orifices de ventilation.
- Ne pas manipuler le cordon d'alimentation avec les mains mouillées.
- Ne pas recouvrir les ouïes de ventilation avec un objet quelconque comme une nappe, un journal, un rideau, etc.
- Ne placer aucune source de flamme nue, comme une bougie allumée, sur l'appareil.
- Pour mettre au rebut les piles usées, respecter les lois gouvernementales ou les règlements officiels concernant l'environnement qui s'appliquent à votre pays ou région.
- Veiller à ce qu'aucun objet ne soit à moins de 0,2 mètre des côtés de l'appareil.
- Aucun objet rempli de liquide, un vase par exemple, ne doit être placé sur l'appareil.
- Lorsque l'interrupteur est sur la position OFF, l'appareil n'est pas complètement déconnecté du SECTEUR (MAINS).
- L'appareil sera installé près de la source d'alimentation, de sorte que cette dernière soit facilement accessible.
- Ne pas toucher aux zones chaudes, notamment celles se trouvant autour du « signal zone chaude » pendant et immédiatement après l'utilisation.
- Pendant l'utilisation et immédiatement après, cet appareil est chaud en dehors des commandes et des prises de raccordement arrière. Ne pas toucher aux zones chaudes, notamment celles se trouvant autour du « signal zone chaude » et le panneau supérieur, pour éviter tout risque de brûlure.



Signal zone chaude

- N'exposez pas l'appareil et les piles à une chaleur excessive, comme par exemple aux rayons directs du soleil, au feu, etc.

Deutsch

WARNHINWEISE

- Das Gerät nicht Regen, Feuchtigkeit, Tropf- oder Spritzwasser aussetzen.
- Die Abdeckung nicht vom Gerät abnehmen.
- Keine Gegenstände durch die Belüftungsschlitze stecken.
- Das Netzkabel nicht mit feuchten oder nassen Händen anfassen.
- Decken Sie die Lüftungsöffnungen nicht mit einem Tischtuch, einer Zeitung, einem Vorhang usw. ab.
- Es dürfen keine Gegenstände mit offener Flamme, wie etwa brennende Kerzen, auf dem Gerät aufgestellt werden.
- Beachten Sie bei der Entsorgung der verbrauchten Batterien alle geltenden lokalen und überregionalen Regelungen.
- Auf allen Geräteseiten muß ein Zwischenraum von ungefähr 0,2 meter vorhanden sein.
- Auf das Gerät dürfen keine mit Flüssigkeiten gefüllte Behälter, wie etwa eine Vase, gestellt werden.
- Wenn der Schalter ausgeschaltet ist (OFF-Position), ist das Gerät nicht vollständig vom Stromnetz (MAINS) abgetrennt.
- Das Gerät sollte in der Nähe einer Netzsteckdose aufgestellt werden, damit es leicht an das Stromnetz angeschlossen werden kann.
- Berühren Sie während oder unmittelbar nach dem Gebrauch keine heißen Stellen des Gerätes, insbesondere nicht im Bereich des Warnsymbols "Vorsicht, heiße Oberfläche".
- Während oder unmittelbar nach dem Gebrauch ist dieses Gerät mit Ausnahme der Bedienelemente und der Anschlussbuchsen auf der Rückseite heiß. Berühren Sie die heißen Stellen und insbesondere den Bereich um das Warnsymbol "Vorsicht, heiße Oberfläche" nicht. Der Kontakt mit heißen Flächen kann zu Verbrennungen führen.



Warnsymbol "Vorsicht, heiße Oberfläche"

- Setzen Sie das Gerät und die Batterien keiner übermäßigen Wärme aus, z.B. durch Aufstellung in direkter Sonneneinstrahlung, in der Nähe eines offenen Feuers usw.

Nederlands

WAARSCHUWINGEN

- Stel het apparaat niet bloot aan regen, vocht, druppels of spetters.
- Verwijder de afdekplaat van het apparaat niet.
- Duw niets door de ventilatieopeningen in het apparaat.
- Raak het netsnoer niet met natte handen aan.
- Bedek de ventilatieopeningen niet met enige voorwerpen, zoals tafelkleden, kranten, gordijnen, enz.
- Plaats geen brandende voorwerpen, zoals kaarsen, op het apparaat.
- Volg bij het weggooien van verbruikte batterijen de overheidswetgeving of milieuvoorschriften op die van kracht zijn in het land of de regio waarin u zich bevindt.
- Zorg dat er 0,2 meter vrije ruimte rond het toestel is.
- Plaats geen voorwerpen met een vloeistof erin, zoals een bloemenvaas, op het apparaat.
- Als de schakelaar op OFF staat, is het apparaat niet volledig losgekoppeld van de netspanning (MAINS).
- De apparatuur wordt in de buurt van het stopcontact geïnstalleerd, zodat dit altijd gemakkelijk toegankelijk is.
- Raak hete gedeelten van het apparaat, vooral rond de "markering warm oppervlak", niet aan tijdens en onmiddellijk na het gebruik.
- Tijdens en onmiddellijk na het gebruik is dit apparaat heet, behalve in de omgeving van de bedieningstoetsen en de aansluitingen op het achterpaneel. Raak hete gedeelten van het apparaat, vooral rond de "markering warm oppervlak" en het bovenpaneel, niet aan. Contact met hete plekken kan brandwonden veroorzaken.



Markering warm oppervlak

- Stel het apparaat en de batterijen niet bloot aan grote warmte, zoals direct zonlicht, vuur en dergelijke.

Italiano

AVVERTENZE

- Non esporre l'apparecchio alla pioggia, all'umidità, al gocciolamento o agli spruzzi.
- Non rimuovere il coperchio dell'apparecchio.
- Non introdurre oggetti all'interno dell'apparecchio attraverso i fori di ventilazione.
- Non toccare il cavo di alimentazione con le mani bagnate.
- Non coprire le fessure di ventilazione con tovaglie, giornali, tende od oggetti analoghi.
- Non posare sull'apparecchio sorgenti di fiamme scoperte quali candele accese.
- Smaltire le pile usate in conformità alle norme governative o disposizioni ambientali vigenti nel proprio paese o zona.
- Lasciare 0,2 metro liberi tutto intorno l'unità.
- Non mettere sull'apparecchiatura alcun contenitore di liquido, come ad esempio dei vasi.
- Quando l'interruttore è nella posizione OFF, l'apparecchiatura non è completamente scollegata da MAINS.
- L'apparecchio va installato in prossimità della fonte di alimentazione, in modo che quest'ultima sia facilmente accessibile.
- Non toccare le parti calde, né durante, soprattutto se contrassegnate dal "simbolo di superficie calda", né immediatamente dopo l'uso.
- Durante, e subito dopo l'utilizzo, l'unità risulta essere molto calda in alcune sue parti come ad esempio i connettori del pannello posteriore. Non toccare le parti calde, soprattutto se contrassegnate dal "simbolo di superficie calda" e specialmente la superficie del pannello. Il contatto con parti calde può provocare ustioni.



Simbolo di superficie calda

- Non esporre l'unità e le batterie a calore eccessivo come la luce diretta del sole, il fuoco o così via.

Thank you for selecting the Marantz PM-11S2 Integrated amplifier for your Audio system. Please read these operating instructions carefully. We recommend that you read the entire user guide before you attempt to connect or operate the player. After you have reviewed the contents of this manual, we suggest that you make all system connections before you attempt to operate the unit.

■ Checking the accessories

After opening the cover of the packing box, check that the following accessories are included.

- Remote controller

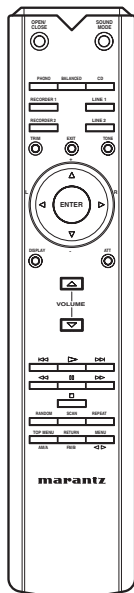

- User Guide

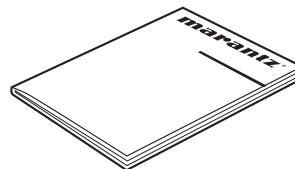

- Warranty Card (U.S.A)
(U.S.A. x 1, Canada x 1)

- Size “AAA” batteries x 2

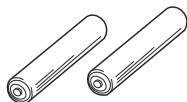

- AC Power cord
PM-11S2 (U.S.A.)

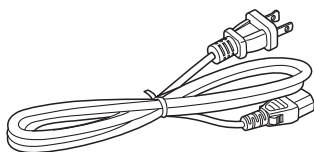

PM-11S2 (Europe)

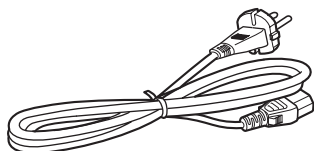

A NOTE ABOUT RECYCLING



This product's packaging materials are recyclable and can be reused. This product and the accessories packed together are the applicable product to the WEEE directive except batteries. Please dispose of any materials in accordance with your local recycling regulations. When discarding the unit, comply with your local rules or regulations. Batteries should never be thrown away or incinerated but disposed of in accordance with your local regulations concerning chemical wastes.

CONTENTS

FEATURES	3
BEFORE USING	4
EQUIPMENT MAINS WORKING SETTING.....	4
COPYRIGHT	4
INAPPROPRIATE PLACES FOR INSTALLATION	4
USAGE OF REMOTE CONTROLLER	5
NAMES AND FUNCTIONS	6
FRONT PANEL.....	6
DISPLAY	7
REMOTE CONTROLLER	8
REAR PANEL.....	9
BASIC CONNECTIONS	10
CONNECTING AUDIO COMPONENTS	10
BALANCED JACKS	11
CONNECTING SPEAKER SYSTEMS.....	12
WIRING SPEAKER CABLE	13
CONNECTING OF AC POWER CABLE.....	13
BASIC OPERATIONS	14
PLAYBACK.....	14
REMOTE CONTROL OPERATION.....	15
ADVANCED CONNECTIONS	16
BI-WIRING CONNECTION	16
STEREO COMPLETE BI-AMP CONNECTION	17
SPEAKER POSITIONING FOR SUPER AUDIO MULTI-CHANNEL SOUND.....	18
BASIC CONNECTION FOR 5.1 MULTI-CHANNEL PLAYBACK	19
F.C.B.S.	20
ADVANCED OPERATIONS	21
HOW TO SET ID NUMBERS	21
BI-AMP MODE	21
TRIMMING	22
ATT. (ATTENUATION)	24
HOW TO OPERATE THE SIDE ILLUMINATION	24
TROUBLESHOOTING	25
OTHERS	27
SPECIFICATIONS & DIMENSIONAL DRAWINGS.....	27

FEATURES

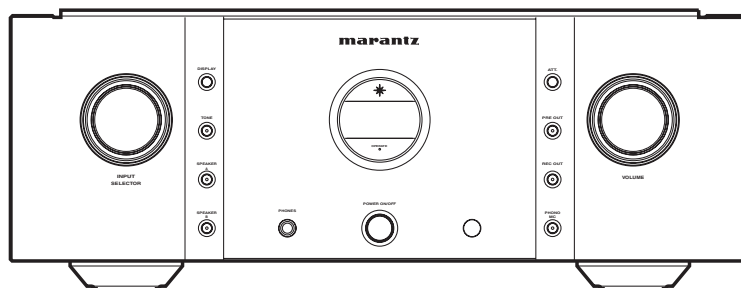

This is an integrated amplifier based on the SC-7S2/MA-9S2 flagship models from Marantz, using leading-edge technologies developed for the higher-grade SC-11S1/SM-11S1 models.

● HDAM®SA3

The latest HDAM®SA3, featured in the higher-grade SC-11S1/SM-11S1, is provided with this model. Compared with the previous HDAM®SA2, the HDAM®SA3 has further improved temperature stability and substantially higher-speed processing. The HDAM®SA3 is incorporated into many components, such as the current feedback phono equalizer, balance buffer, and input buffer.

Input Amplifier Section

● Constant Current Feedback Phono Equalizer

The Constant Current Feedback Phono Equalizer of the higher-grade SC-11S1 model is also provided with this model.

This equalizer, developed by Marantz, has the advantages of both NF-type and CR-type phono equalizers, and it supports both MM and MC cartridges.

● Current Feedback Balance Buffer Amplifier

The Current Feedback Balance Buffer Amplifier, which incorporates the HDAM®SA3 amp module, is provided with this unit, in order to faithfully convey signals from Super Audio CD players and D/A converters that have high-quality balanced output.

● Dedicated Input Buffers for All Line Input Jacks

Each CD, LINE 1, LINE 2, RECORDER 1, and RECORDER 2 input jack has its own input buffer amplifier that incorporates an HDAM®SA3. Those buffer amplifiers prevent mutual interference among input sources, for faithful transmission of signals from input sources.

Preamp Section

● Linear Control Volume

The Linear Control Volume based on the design concept for the SC-7S2 is incorporated. For better S/N ratio, the WM8816 from Wolfson and the HDAM®SA3 have been combined, which enables smooth adjustment in the range of 0 to -100 dB in units of ± 0.5 dB.

● Tone Control Amplifier

The electronic tone control amplifier is provided for adjustment of bass (low frequency) and treble (high frequency) sound in units of 2 dB in the range of -8 to +8 dB. Adjustment can be separately performed for the L and R channels, using the remote control unit.

Power Amplifier Section

● Dual-Amplifier Structure

Following the design concept of the MA-9S2, this unit was developed with the dual structure of a voltage amplifier and power buffer amplifier. This dual structure enables the power buffer amplifier to drive the speakers powerfully, preventing influence from the back electromagnetic force from the speakers. The voltage amplifier drives the power buffer with superlow distortion.

Power Circuit

● Choke Input Power Supply Circuit

This unit incorporates a choke input power circuit that uses a large-capacity smoothing capacitor, in order to thoroughly eliminate high-frequency noise from the rectifier circuit and external sources. The choke input power circuit supplies clean power to the input amplifier and preamplifier sections.

Functions

● BI-AMP Mode

Complete bi-amp connection proposed by Marantz enables a level of reproduction of the acoustic field never before achieved. That complete bi-amp connection is available with the PM-11S2. Synchronized operation of two PM-11S2 units is made possible by F.C.B.S. connection, with each PM-11S2 in Bi-Amp mode working as a monaural integrated amplifier.

● F.C.B.S.

A Floating Control Bus System (F.C.B.S.) enables the user to connect up to four PM-11S2 units, making a diversity of applications possible with complete bi-amp and multichannel connections. Moreover, a ground loop is not formed among multiple PM-11S2 units connected; therefore, sound quality is not adversely affected.

● Display

This unit adopts an LCD (Liquid Crystal Display) to display the input source and volume level. Compared with other types of display panels, an LCD requires less drive power and generates less radiation noise, which minimizes any adverse effect on sound quality.

BEFORE USING

This section must be read before any connection is made to the mains supply.

EQUIPMENT MAINS WORKING SETTING

Your Marantz product has been prepared to comply with the household power and safety requirements that exist in your area.

- Power requirements (U.S.A.)AC 120V 60Hz
- Power requirements (Europe)AC 230V 50/60Hz

COPYRIGHT

Recording and playback of any material may require consent. For further information refer to the following:

- Copyright Act 1956
- Dramatic and Musical Performers Act 1958
- Performers Protection Acts 1963 and 1972
- Any subsequent statutory enactments and orders

INAPPROPRIATE PLACES FOR INSTALLATION

To keep your amplifier in perfect working order for the longest possible time, avoid installing the unit in the following locations.

- Wherever it will be exposed to direct sunlight
- Wherever it will be close to a heater or other heat-radiating appliance
- Wherever the humidity is high or ventilation is poor
- Wherever it is very dusty
- Wherever it will be subject to vibration
- On top of a rickety stand or in an unstable location which is tilted at an angle
- In an audio rack with little space at the top and bottom or other location where the heat dissipation will be obstructed

To ensure proper heat dissipation, install the unit while leaving clearances between the unit and wall or other components, as shown in the figure below.

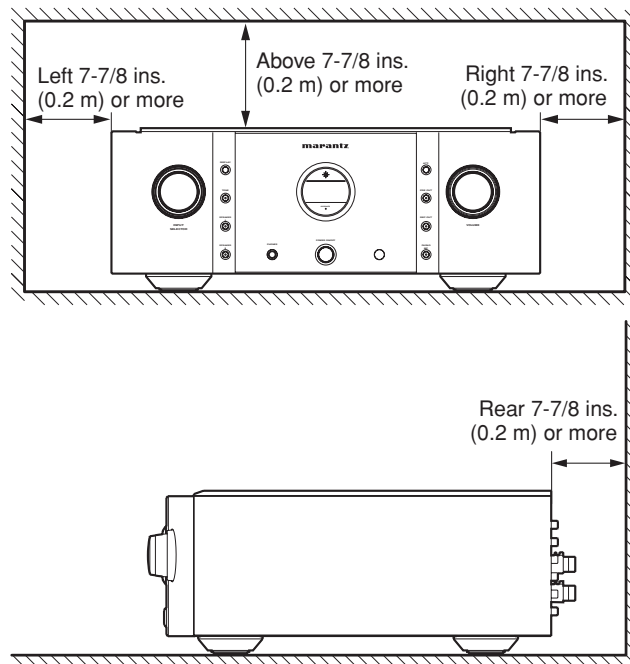

■ Do not place objects on top

- Refrain from placing any objects on top of the unit.

■ Cautions on handling power cord

- Do not touch the power cord with wet hands.
- When disconnecting the power cord, always make sure that you take hold of the plug. Yanking out or bending the cord can damage it and/or cause electric shocks or a fire.
- Get into the habit of disconnecting the power plug before leaving home.

BEFORE USING

USAGE OF REMOTE CONTROLLER

■ Loading batteries

Before using the remote controller for the first time, load the batteries in the remote controller. The batteries provided are used to verify the operations of the remote controller only.

1. Remove the battery cover.

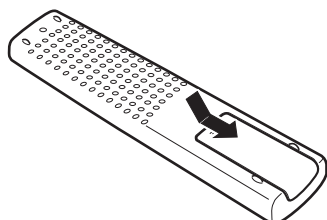

2. Insert the batteries with correct +/- orientation.

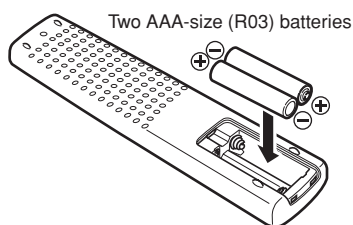

3. Close the battery cover until it clicks shut.

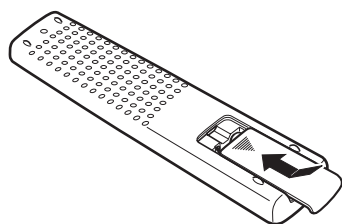

Cautions on handling batteries

Misuse of the batteries can result in electrolyte leakage, rupturing, corrosion, etc.

Bear in mind the following points when using batteries.

- Remove the batteries from the remote control unit if the unit is not going to be used for a prolonged period (a month or more).
- Do not use an old battery together with a new one.
- Insert the batteries while ensuring that their \oplus and \ominus poles are properly aligned with the corresponding markings on the remote control unit.
- Batteries with the same shape may have different voltages. Do not use different types of batteries together.
- If electrolyte has leaked, thoroughly wipe the inside of the battery compartment, and then insert new batteries.
- When batteries which are no longer required are to be discarded, follow the directions (regulations) laid down by the local authorities in the area concerned for their disposal.

■ Operational range

Operate the unit with the remote controller within the range of the illustration below.

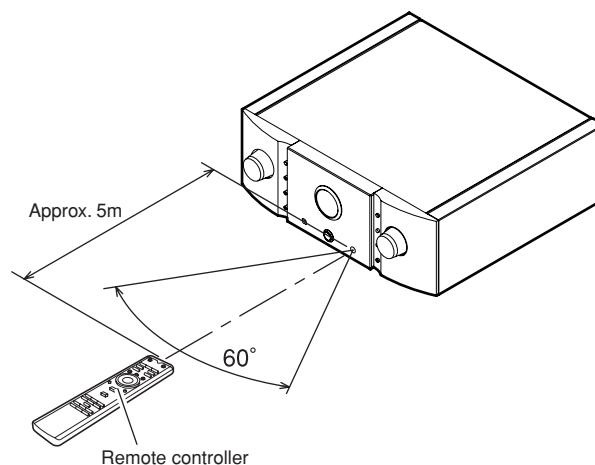

Precautions

- Do not allow direct sunlight, an inverter fluorescent light or other strong source of light to shine onto the player's infrared signal reception window (remote sensor). Otherwise, the operation of the remote control unit may be disabled.
- Bear in mind that operating the remote control unit may cause other devices operated by infrared rays to be operated by mistake.
- The remote control unit cannot be operated if the space between the controller and the player's remote sensor is obstructed.
- Do not place any objects on top of the remote control unit. Doing so may cause one or more buttons to be held down which will cause the batteries to run down.

NAMES AND FUNCTIONS

FRONT PANEL

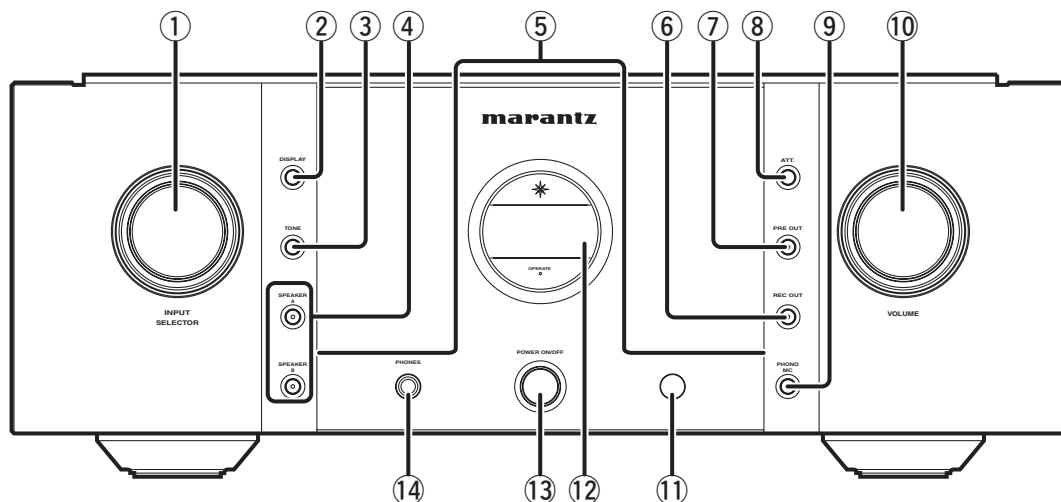

① INPUT SELECTOR Knob

This knob is for selecting the input source to use in playback and recording. The selected input source is displayed in the display ⑫.

② DISPLAY Button

This button turns the display and side illumination ON and OFF. For instructions on **HOW TO OPERATE THE SIDE ILLUMINATION**, see page. 24.

③ TONE Button

This button turns the bass and treble tone control ON and OFF. For instructions on **How to Trim Bass and Treble**, see page. 23.

④ SPEAKER A/B Buttons

These buttons turn the speaker output to the speakers connected to the SPEAKER SYSTEM A/B terminals on the rear panel ON and OFF. To listen with headphones, turn speaker output OFF.

⑤ Illumination Lamp

The illumination lamp casts a blue light over the switches and buttons. It can be turned ON and OFF with the DISPLAY button. For instructions on **HOW TO OPERATE THE SIDE ILLUMINATION**, see page. 24.

⑥ REC OUT Button

This button turns the signals output from the RECORDER 1 and 2 OUT jacks on the rear panel ON and OFF. When RECORDER 1 is selected as the input source, signals are not output to the RECORDER 1 OUT jack. The same goes for the RECORDER 2 OUT jack when RECORDER 2 is selected as the input source.

⑦ PRE OUT Button

This button is for turning the output signal from the PRE OUT jacks on the rear panel ON and OFF.

⑧ ATT. Button

This button attenuates the volume with one press of the button. For instructions on **How to Set the Attenuation Level**, see page. 24.

⑨ PHONO MC Button

This button switches the phono equalizer between MC and MM. When MC is set, the center of the button is lit a blue color. Set the phono equalizer amplifier according to the type of cartridge you use.

⑩ VOLUME Knob

This knob is for setting the volume. The volume level is displayed on the display ⑫. When turned slowly, the volume can be fine-adjusted in 0.5dB steps, whereas when turned rapidly, the volume level changes greatly.

⑪ Infrared Receptor Window

This receptor window receives control signals sent from the included remote controller.

⑫ Display

Indicate the selected input source, volume level, and setting status.

⑬ POWER ON/OFF Switch

This switch turns power to the unit ON and OFF. When pressed, power is activated and the blue indicator in the display ⑫ lights up. Pressing the switch again turns the power OFF.

⑭ PHONES Jack

This jack is for connecting headphones with a standard stereo plug.

NAMES AND FUNCTIONS

DISPLAY

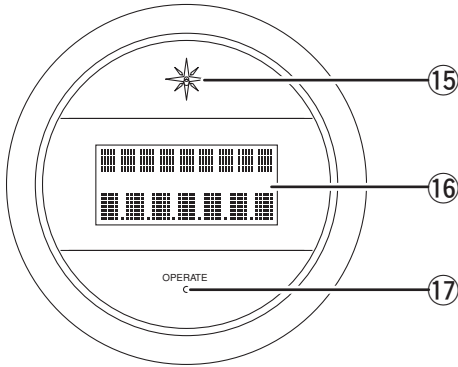

15 Power Indicator

This indicator is lit a blue color while power to the unit is ON.

16 Display Panel

Approximately 3 seconds after the power to the unit is activated, the ID number is displayed here.



After that, the top line displays the selected input source, and the bottom line displays the volume level. The volume attenuation (dB units) is displayed.



VOLUME Indicator Volume Display

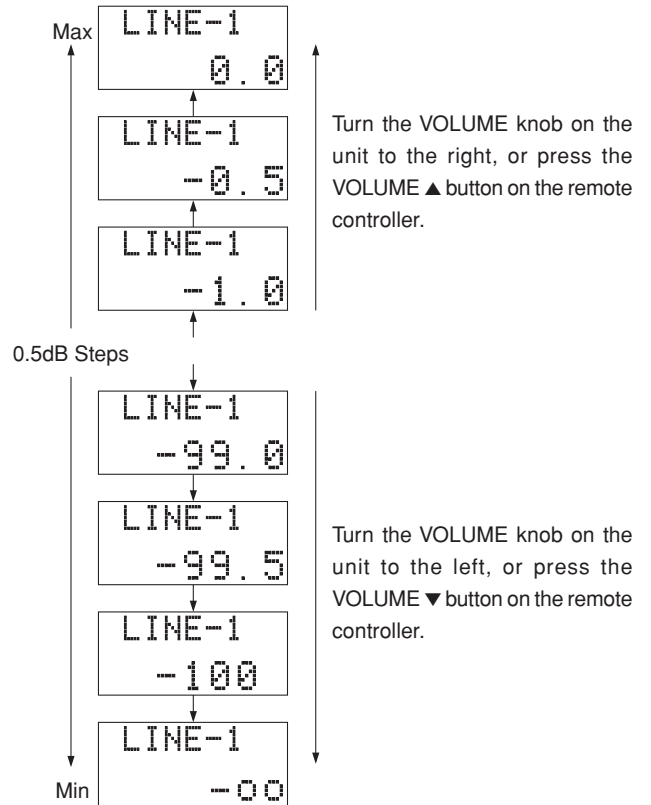

The display also displays the setting values when adjusting the left-right level balance. For instructions on **How to Trim Volume Level**, see page. 22. Other messages that correspond to various operations are also displayed.

17 OPERATE Indicator

This indicator flashes the operating status of the unit. When the ID is set to "0" for standalone operation, it is lit a red color. When multiple amplifiers are connected by F.C.B.S., only ID number "1" for the master is lit red color. The slave amplifier whose indicator does not light a red color cannot be used to operate other units in sync. For more information on **F.C.B.S.**, see page. 20. The indicator flashes red if a protective circuit trips.

NAMES AND FUNCTIONS

REMOTE CONTROLLER

This remote controller can be used to control the PM-11S2 and Marantz Super Audio CD players or DVD players that have a remote control receptor. The operations possible by remote control may differ with each component, therefore see the instruction manual that came with the component.

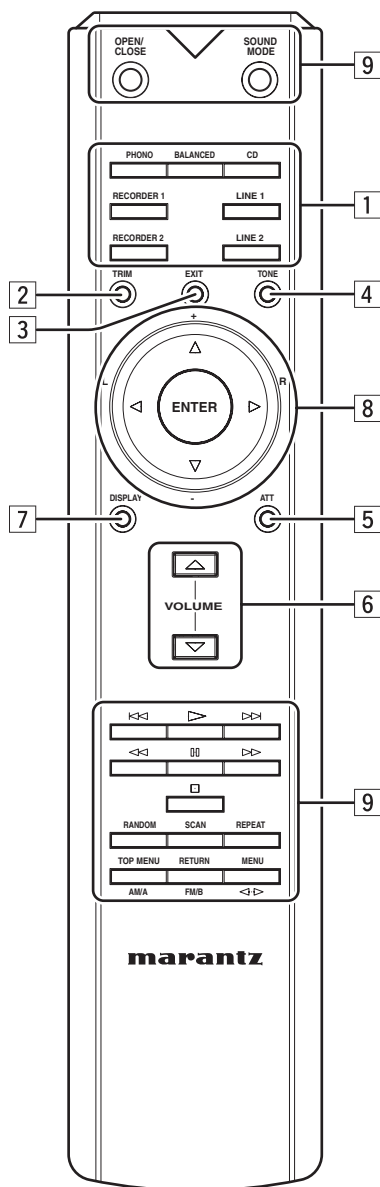

1 Input Selector Buttons

These buttons are for selecting the input source to use in playback.

2 TRIM Button

This button starts the various trim adjustments. (Page. 22)

When multiple units are connected by F.C.B.S., this button selects the unit with which to perform trimming.

3 EXIT Button

This button ends the trimming mode when trimming is finished.

4 TONE Button

This button turns tone (bass /treble) control ON and OFF.

5 ATT Button

This button attenuates volume level with one press. (page. 24)

6 Volume Buttons

▲ : This button increases the volume level.
▼ : This button decreases the volume level.

7 DISPLAY Button

This button turns the display ON and OFF.

8 Cursor Buttons

In the Trimming Mode

These buttons are for selecting the channel to trim and the trimming level.

ENTER : This button selects the trim mode (LEVEL/BASS/TREBLE).

▶ / R : This button selects the R channel for trimming.

◀ / L : This button selects the L channel for trimming.

▲ / + : This button increases the trimming level.

▼ / - : This button decreases the trimming level.

Other than the Trimming Mode

▶, ◀, ▲, ▼ and ENTER: These buttons are for selecting settings items on menu displays of Marantz DVD players, etc. For operations of supported Marantz products, see the tables on the 15 page and the instruction manual of the Marantz component.

9 Component Operating Buttons

These buttons are for operating Marantz Super Audio CD players, DVD players, etc. For operations of supported Marantz products, see the tables on the 15 page and the instruction manual of the Marantz component.

NAMES AND FUNCTIONS

REAR PANEL

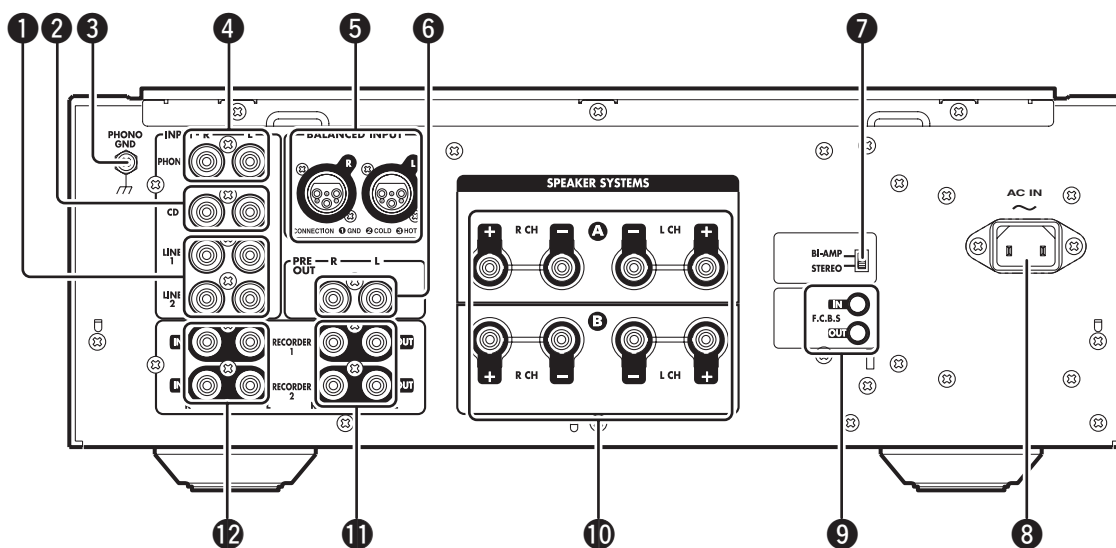
**1 LINE 1/2 Input Jacks**

These jacks are for connecting to the output jacks of a tuner, DVD player, etc.

2 CD Input Jacks

These jacks are for connecting to the output jacks of a Super Audio CD player, etc.

3 PHONO GND Terminal

Connect the grounding wire from an analog record player here.

4 PHONO Input Jacks

These jacks are for connecting to an analog record player. Both MC and MM cartridges can be used, therefore set the PHONO MC button on the front panel according to the type of cartridge you are using.

5 BALANCED Jacks

These jacks are for connecting to the balanced output jacks of a Super Audio CD player, etc.

6 PRE OUT Jacks

These jacks are for connecting to the input jacks of another main amplifier or active subwoofer. Output signals can be turned ON/OFF from the PRE OUT button on the front panel.

7 AMP MODE Switch

STEREO: Set to use this unit as a normal two-channel stereo amplifier.

BI-AMP: Set to use this unit in complete bi-amp connection.

For more information on **BI-AMP MODE**, see page. 21.

8 AC IN Power Cable Connection Socket

Connect this socket to the power outlet using the included power cord.

9 F.C.B.S. IN/OUT Jacks

These jacks are used to connect and synchronize up to four amplifiers. For instructions on use and connections, see **F.C.B.S.** (page. 20).

10 SPEAKER SYSTEMS Output Terminals

You can connect 2 speaker systems to the PM-11S2. Speaker output can be turned ON/OFF from the SPEAKER A and B buttons on the front panel.

11 RECORDER 1/2 Output Jacks

These jacks are for connecting to the recording input jacks of a tape deck etc.

Output signals can be turned ON/OFF from the REC OUT button on the front panel.

12 RECORDER 1/2 Input Jacks

These jacks are for connecting to the output jacks of a tape deck or other type of recording device.

BASIC CONNECTIONS

CONNECTING AUDIO COMPONENTS

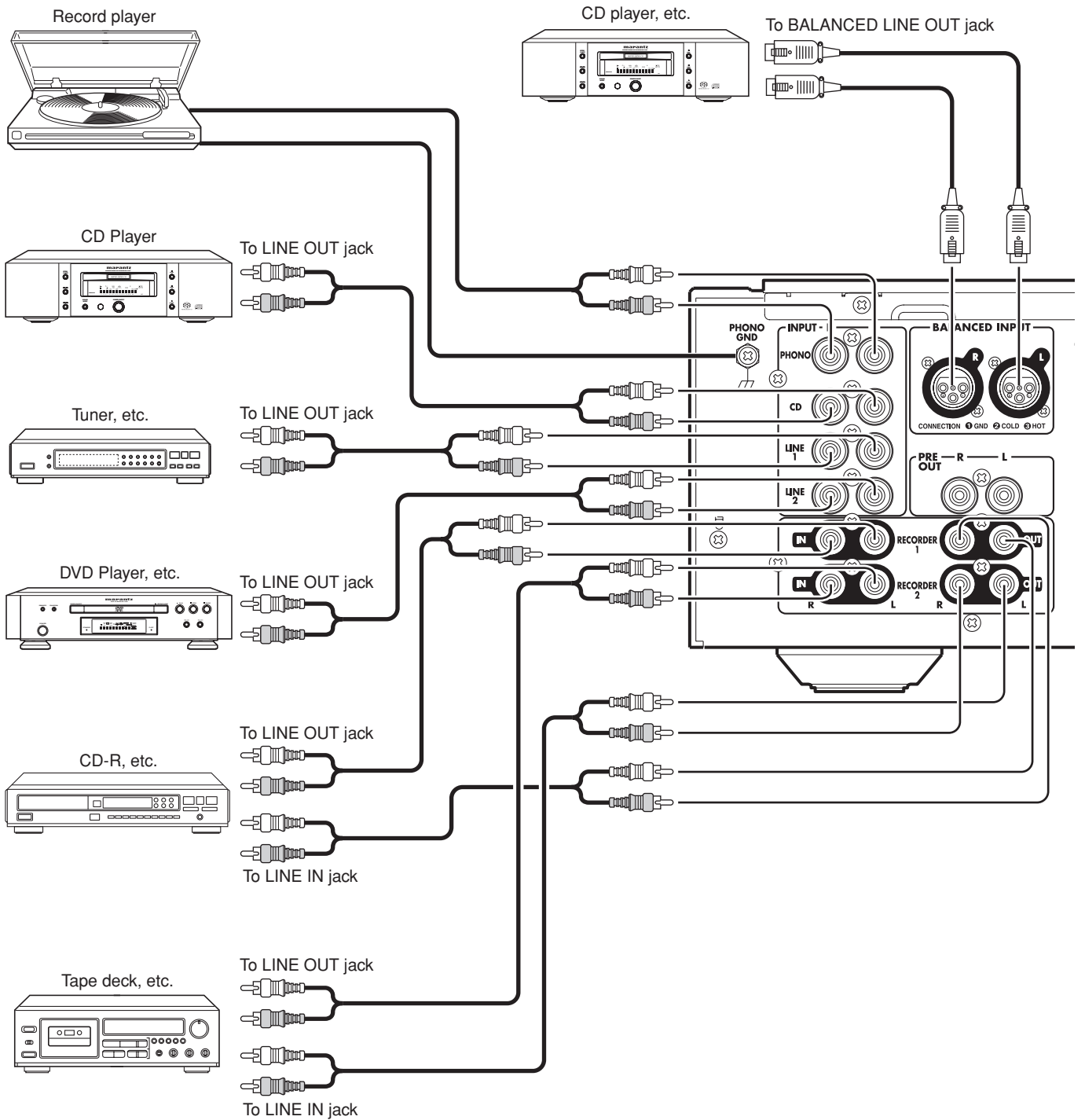

NAMES AND FUNCTIONS

BASIC CONNECTIONS

BASIC OPERATIONS

ADVANCED CONNECTIONS

ADVANCED OPERATIONS

TROUBLESHOOTING

OTHERS

BASIC CONNECTIONS

Notes:

- Do not connect the power cord of this unit or any of the other components to the power supply until all of the connections are completed.
- Insert the plugs of the connections cords firmly into the connecting jacks. Incorrect insertion may cause noise.
- Connect the wires correctly to the L (left) and R (right) channels. The red jack is the R (right) channel, and the white jack is the L (left) channel.
- Make sure that input and output are connected correctly.
- Refer also to the instruction manuals of components to connect equipment correctly.

BALANCED JACKS

- ① The BALANCED jacks on this unit are equipped with XLR connectors that are widely used on professional equipment. Their features are listed below.
 - The 3 pin construction enables the musical signal to be transmitted as a balanced signal, with little effect from external noise
 - The detachable locking mechanism minimizes connector play and enhances connection reliability.
- ② The XLR connector for professional use is internally wired in either of the following two systems.
 1. USA system (Pin ② = COLD, Pin ③ = HOT)

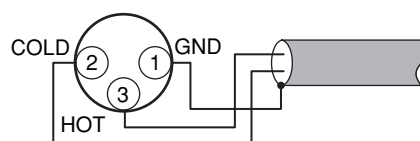

2. European system (Pin ② = HOT, Pin ③ = COLD)

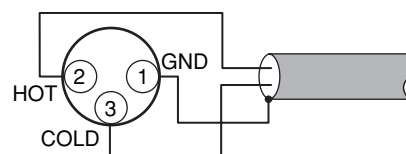

- ③ This unit uses the 1. USA system.

If a product that employs the European system is connected with this unit via a balanced cable, the reproduced signal may be phase-inverted.

In this case, refer to “ANALOG OUTPUT CONNECTOR PHASE SWITCHING”, and set so that the correct phase is used.

BASIC CONNECTIONS

CONNECTING SPEAKER SYSTEMS

- If using an active subwoofer, set the PRE OUT button on the front panel to ON.
- Your speaker system needs to meet the following requirements. If speakers that do not meet the following requirements are used, the amplifier protective circuit may trip, and sounds will not playback correctly. In certain cases, damage may also be caused to the amplifier and speaker system.
 - If using 1 set of speakers, total speaker impedance must be 4Ω or more.
 - If using 2 sets of speakers, total speaker impedance must be 8Ω or more.

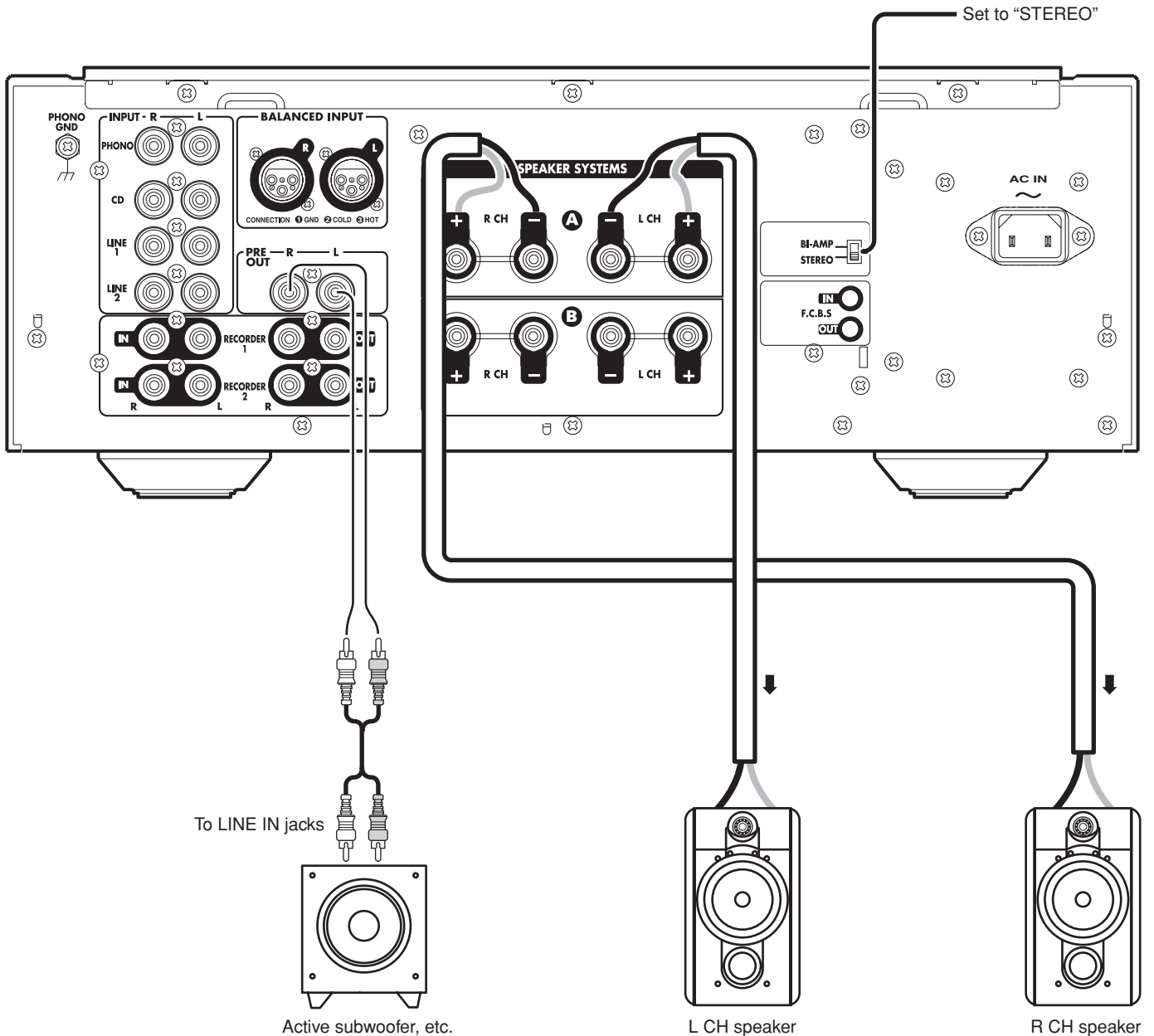

NAMES AND FUNCTIONS

BASIC CONNECTIONS

BASIC OPERATIONS

ADVANCED CONNECTIONS

ADVANCED OPERATIONS

TROUBLESHOOTING

OTHERS

BASIC CONNECTIONS

WIRING SPEAKER CABLE

- Peel off the coating of speaker cable as shown below.

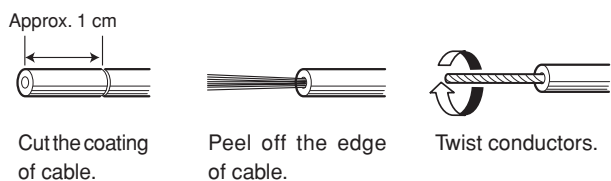

- Wiring with speaker cable.

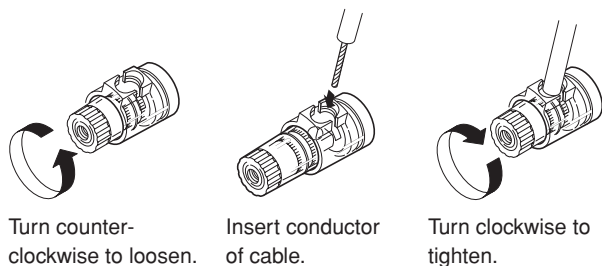

- Wiring with "Y" style terminal

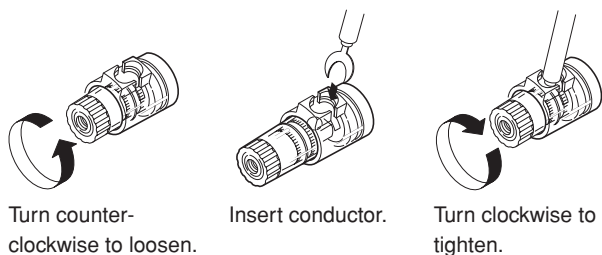

Notes:

- To prevent damage to circuitry, do not let the bare speaker wires touch each other and do not let them touch any metal part of this unit.

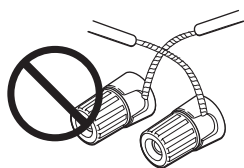

- Do not touch the speaker terminals when the power is on. It may cause you to receive an electric shocks.
- Be sure to connect the positive and negative cables for the speaker properly. If they are miss-connected, the signal phase will be reversed and the signal quality will be corrupted.

CONNECTING OF AC POWER CABLE

1. Plug the supplied AC power cable to the AC IN socket on the rear panel of the main unit.

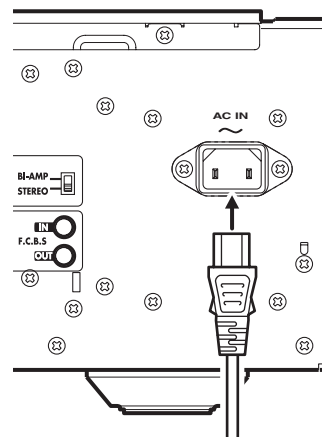

2. Plug the power cable into an AC outlet.

Connect the player so that the power cord can be removed easily as a precaution against possible accidents.

BASIC OPERATIONS

PLAYBACK

To explain how to play back input sources, representative examples are given with an Super Audio CD player and analog record player. Before starting either procedure, check the component is correctly connected to the PM-11S2.

■ Disc Playback on an Super Audio CD Player

1. Press the power ON/OFF switch of the Super Audio CD player to activate power to it.
2. Press the POWER ON/OFF switch ⑬ of the PM-11S2 to activate power to it. When using multiple PM-11S2s connected by F.C.B.S., turn power ON in the order of lowest to highest ID number, starting from ID 1.
3. Select the input source from the INPUT SELECTOR knob ① on the PM-11S2 or the input selector buttons ① of the remote controller.
4. To use the speakers connected to the SPEAKER A terminals, press the SPEAKER A button ④ on the PM-11S2.
5. Load a disc into the Super Audio CD player and press the play button to start playback.
6. Adjust the volume level from the VOLUME knob ⑩ on the PM-11S2 or the VOLUME ▲/▼ buttons ⑥ of the remote controller.
7. Adjust bass/treble as desired from the TONE button ③ on the PM-11S2 or the TONE button ④ of the remote controller. For instructions on how to adjust bass and treble, see "How to Trim Bass" and "How to Trim Treble" on pg. 23.
8. You can turn the display and side illumination ON/OFF as suited for the room environment. Press the DISPLAY button ② on the PM-11S2 or the DISPLAY button ⑦ of the remote controller.

■ Disc Playback on an Analog Record Player

1. Press the POWER ON/OFF switch ⑬ of the PM-11S2 to activate power to it. When using multiple PM-11S2s connected by F.C.B.S., turn power ON in the order of lowest to highest ID number, starting from ID 1.
2. Select "PHONO" as the input source from the INPUT SELECTOR knob ① on the PM-11S2 or the input selector buttons ① of the remote controller. To prevent unexpected accidents, it is recommended to set the volume level to $-\infty$ (mute) by turning the VOLUME knob ⑩ until muting the volume level.
3. Set the PHONO MC button ⑨ on the PM-11S2 to MC or MM according to the cartridge you are using.
4. To use the speakers connected to the SPEAKER A terminals, press the SPEAKER A button ④ on the PM-11S2.
5. Set a record on the analog record player and play it.

6. Adjust the volume level from the VOLUME knob ⑩ on the PM-11S2 or the VOLUME ▲/▼ buttons ⑥ of the remote controller.
7. Adjust bass/treble as desired from the TONE button ③ on the PM-11S2 or the TONE button ④ of the remote controller. For instructions on how to adjust bass and treble, see "How to Trim Bass" and "How to Trim Treble" on pg. 23.
8. You can turn the display and side illumination ON/OFF as suited for the room environment. Press the DISPLAY button ② on the PM-11S2 or the DISPLAY button ⑦ of the remote controller.

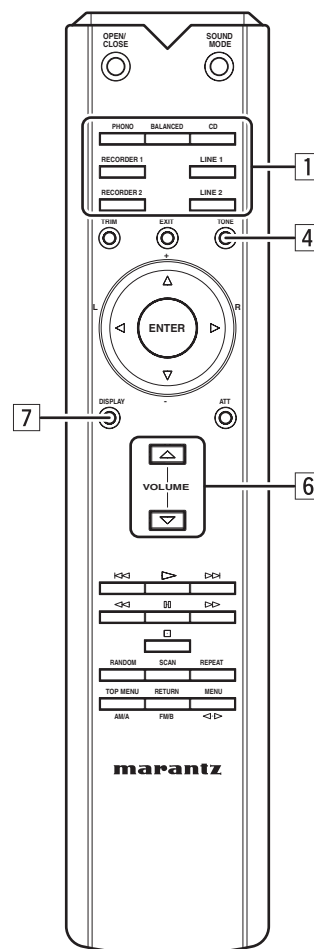
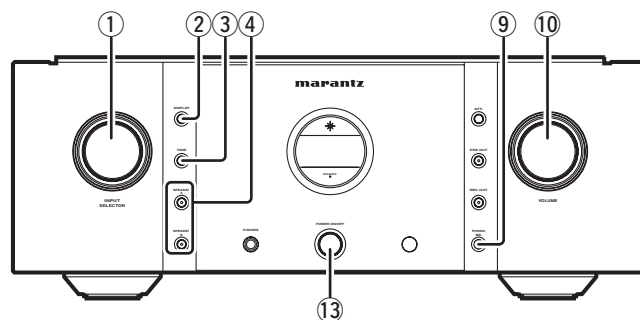

BASIC OPERATIONS

REMOTE CONTROL OPERATION

The buttons in groups [8] and [9] are for operating Marantz products other than the PM-11S2, such as Super Audio CD players or DVD players.

The function of each button changes to match the component selected as the input source from the INPUT SELECT buttons [1].

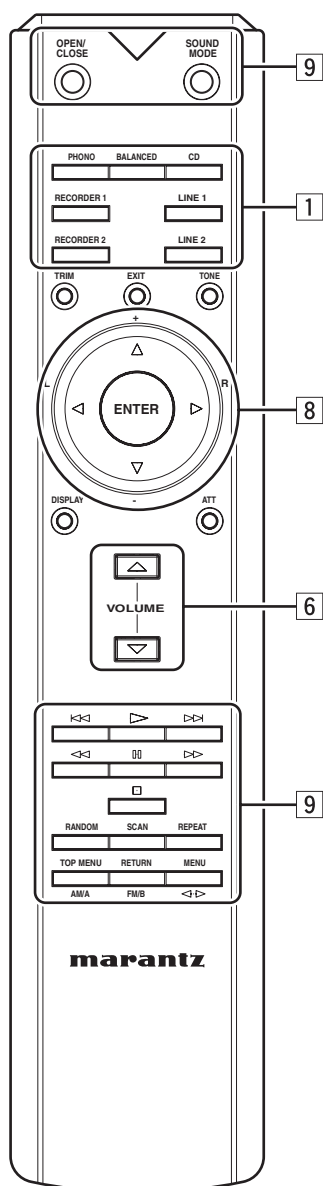

● Remote Controller Operation for Marantz Super Audio CD Players

When the CD button is pressed, the buttons in groups [8] and [9] function as indicated in the table below. These buttons can be used only when a Marantz Super Audio CD player is connected to the CD input jacks.

Button	Function
OPEN/CLOSE	Open/Closes disc tray.
SOUND MODE	Selects Super Audio CD sound mode. Selects Super Audio CD/CD.
▶	Play
⏮	Track skip (Returns to track beginning/previous track.)
⏭	Track skip (Advances to next track.)
⏪	Rewind search
⏩	Forward search
⏸	Pause
■	Stop
RANDAM	Random play
SCAN	AMS (Automatic Music Scan) play
REPEAT	Repeat play
TOP MENU/AM/A	Not available for use
RETURN/FM/B	Not available for use
MENU ◀▶	Sets quick replay.
ENTER	Starts quick replay.
▲ /+	Not available for use
▼ /-	Not available for use
◀ / L	Not available for use
▶ / R	Not available for use

● Remote Controller Operation for Marantz DVD Players

When the LINE 2 button is pressed, the buttons in groups [8] and [9] function as indicated in the below table. These buttons can be used only when a Marantz DVD player is connected to the LINE 2 input jacks.

Button	Function
OPEN/CLOSE	Open/Closes disc tray.
SOUND MODE	Changes sound mode.
▶	Play
⏮	Track skip (Returns to track beginning/previous track.)
⏭	Track skip (Advances to next track.)
⏪	Rewind search
⏩	Forward search
⏸	Pause
■	Stop
RANDAM	Random play
SCAN	Selects search mode.
REPEAT	Repeat play
TOP MENU/AM/A	Displays top menu.
RETURN/FM/B	Returns to previous menu
MENU ◀▶	Displays menu screen.
ENTER	Sets selected item.
▲ /+	Moves cursor upward.
▼ /-	Moves cursor downward.
◀ / L	Moves cursor to left.
▶ / R	Moves cursor to right.

ADVANCED CONNECTIONS

BI-WIRING CONNECTION

A bi-wiring connection separately connects the low and mid/high jacks of the speaker to the amplifier using separate speaker cables. Because separate cables are used for low and mid/high sounds, the return current generated in the low speaker causes little interference with the mid/high speaker.

- If speakers that do not support bi-wiring connection are used, connect them to either the SPEAKER A or B terminals.
- If using speakers that do not support a bi-wiring connection, connect them to either the SPEAKER SYSTEM A or B terminals.

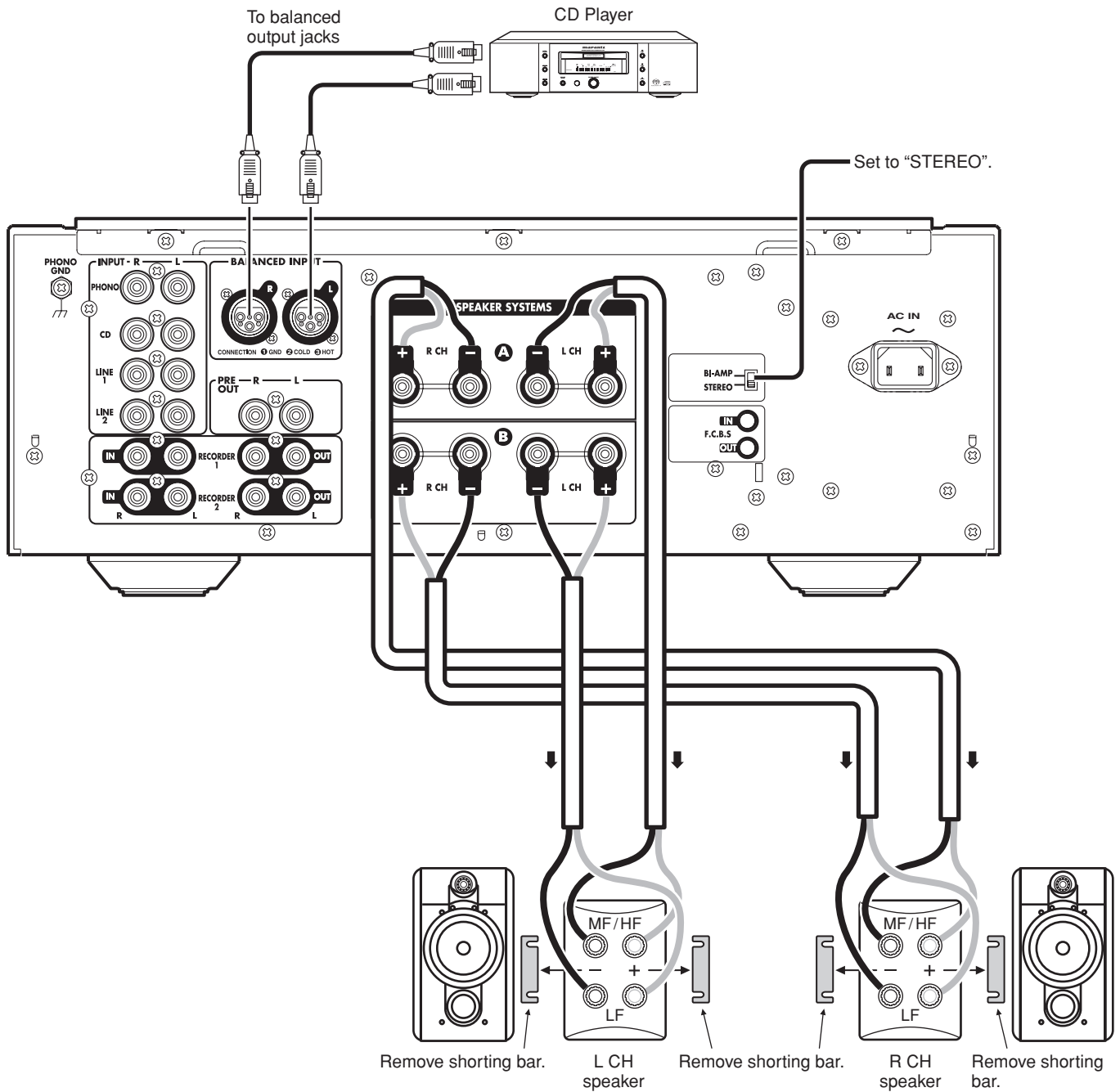

ADVANCED CONNECTIONS

STEREO COMPLETE BI-AMP CONNECTION

- ① The two amplifiers are connected by F.C.B.S. for synchronized use. For F.C.B.S. connection, connect with commercially available monaural ↔ monaural miniplugs or stereo ↔ stereo miniplugs as described in **F.C.B.S.** (page. 20).
- ② Set the ID numbers as explained in **HOW TO SET ID NUMBERS** (page. 21). When the ID1 amplifier is operated, the ID 2 amplifier will operate in sync.
- ③ Connect the analog output of the CD player etc. to the L ch input jacks of both pre-amps.
As both pre-amps operate as monaural pre-amps in BI-AMP mode, do not use the R channel of the input jacks on these units.

● About Complete Bi-Amp

Proposed by Marantz, the complete bi-amp connection is an advanced technique that enhances sound quality. The low and mid/high amplifiers are separated and independent of the preamplifier, therefore interference between low and mid/high sounds is reduced to a minimum. As a result, a wide sound environment can be reproduced.

Note:

Speaker systems connected using complete bi-amp connections must support bi-amp connections. Before connecting your speakers, check in the instruction manual that came with the speakers or contact the manufacturer to confirm whether they support bi-amp connection.

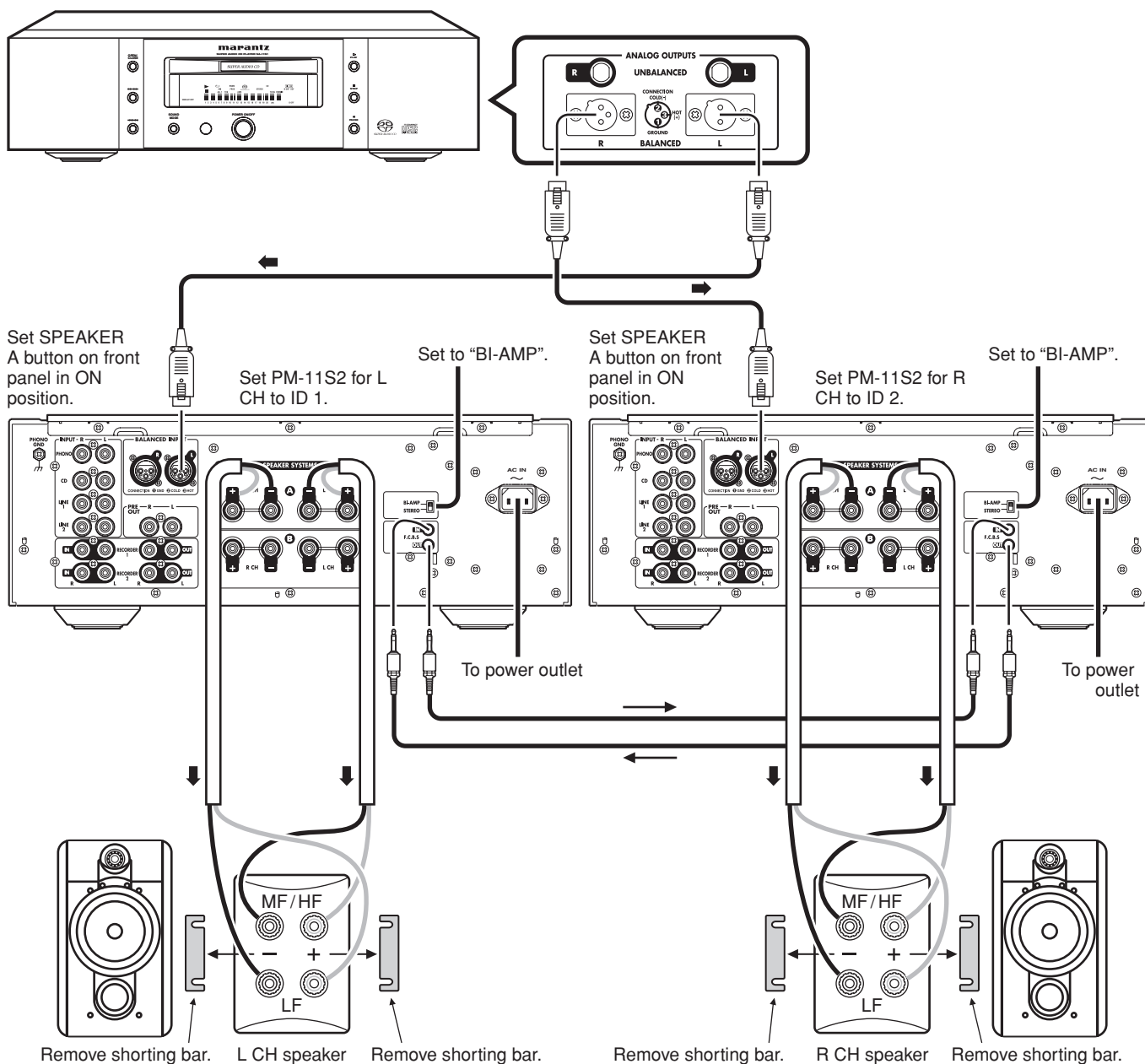

ADVANCED CONNECTIONS

SPEAKER POSITIONING FOR SUPER AUDIO MULTI-CHANNEL SOUND

In order to enjoy Super Audio CD multi-channel sound with the best possible acoustics, it is recommended to position speakers as specified in ITU-R BS.775-1 of the International Telecommunication Union (ITU). Super Audio CD multi-channel discs are recorded and mixed so as to achieve the optimum effect with a speaker system laid out as specified in ITU-R BS.775-1.

- With Super Audio CD multi-channel discs, the music signals are basically recorded using 5 channels (3 - 6 channels sometimes), but in some cases, LFE (for subwoofer) is recorded as a sixth channel. Each disc indicates how many channels have been recorded on it.
- The basic layout is 3 speakers in the front and 2 in the back since multi-channel discs usually have 5 channels. The 2 front, 1 center and 2 surround (rear) speakers should be set in a circle around the listening point as shown below. If using speakers of differing sizes, adjust volume balance from the amplifier.
- The location of the subwoofer in the figure is just for explanatory purposes. It can be located anywhere in the room. For connection and positioning instructions, see the instruction manual that came with the subwoofer.

● **ITU (International Telecommunication Union)**

The ITU is a special organization of the United Nations. It consists of a number of organs, one of which is the Radio Broadcasting Section.

ITU-R BS is the recommendation which consists of standards relating to broadcasting (audio) operations, one of which is the ITU-R BS.775-1 which governs "multi-channel stereo sound systems."

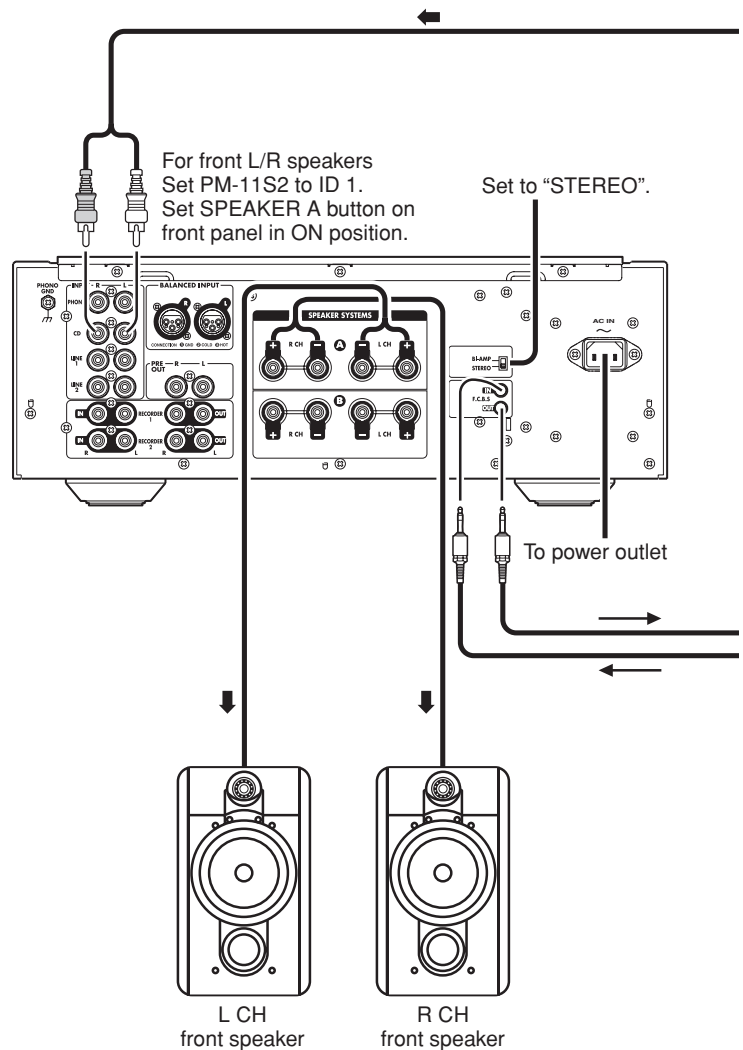
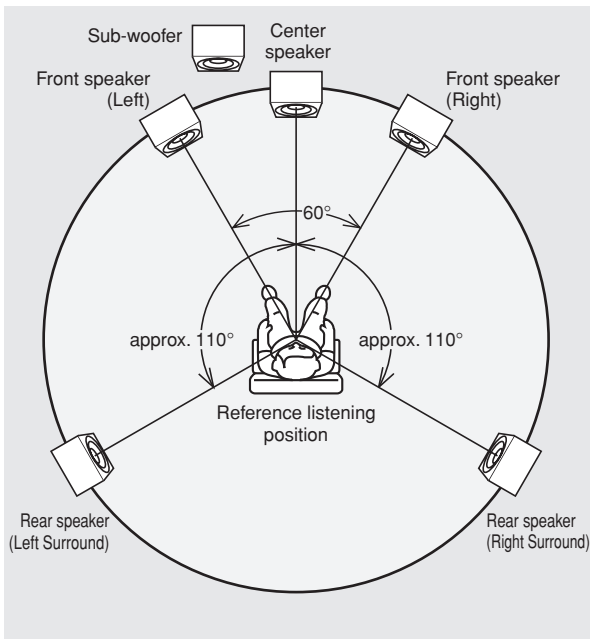

NAMES AND FUNCTIONS

BASIC CONNECTIONS

BASIC OPERATIONS

ADVANCED CONNECTIONS

ADVANCED OPERATIONS

TROUBLESHOOTING

OTHERS

ADVANCED CONNECTIONS

BASIC CONNECTION FOR 5.1 MULTI-CHANNEL PLAYBACK

- ① The three units are connected using F.C.B.S. For the F.C.B.S connection, prepare 3 audio connection cables, and refer to **F.C.B.S.** on page 20.
- ② Set the ID numbers for the three amplifiers as explained in **HOW TO SET ID NUMBERS** (page. 21). When the ID 1 unit is operated, ID 2 and ID 3 units will operate in sync.
- ③ Connect the outputs of players that have 5.1 channel analog outputs to each of the three units.
- ④ If using an active subwoofer, see the instruction manual that came with the subwoofer for further instructions.

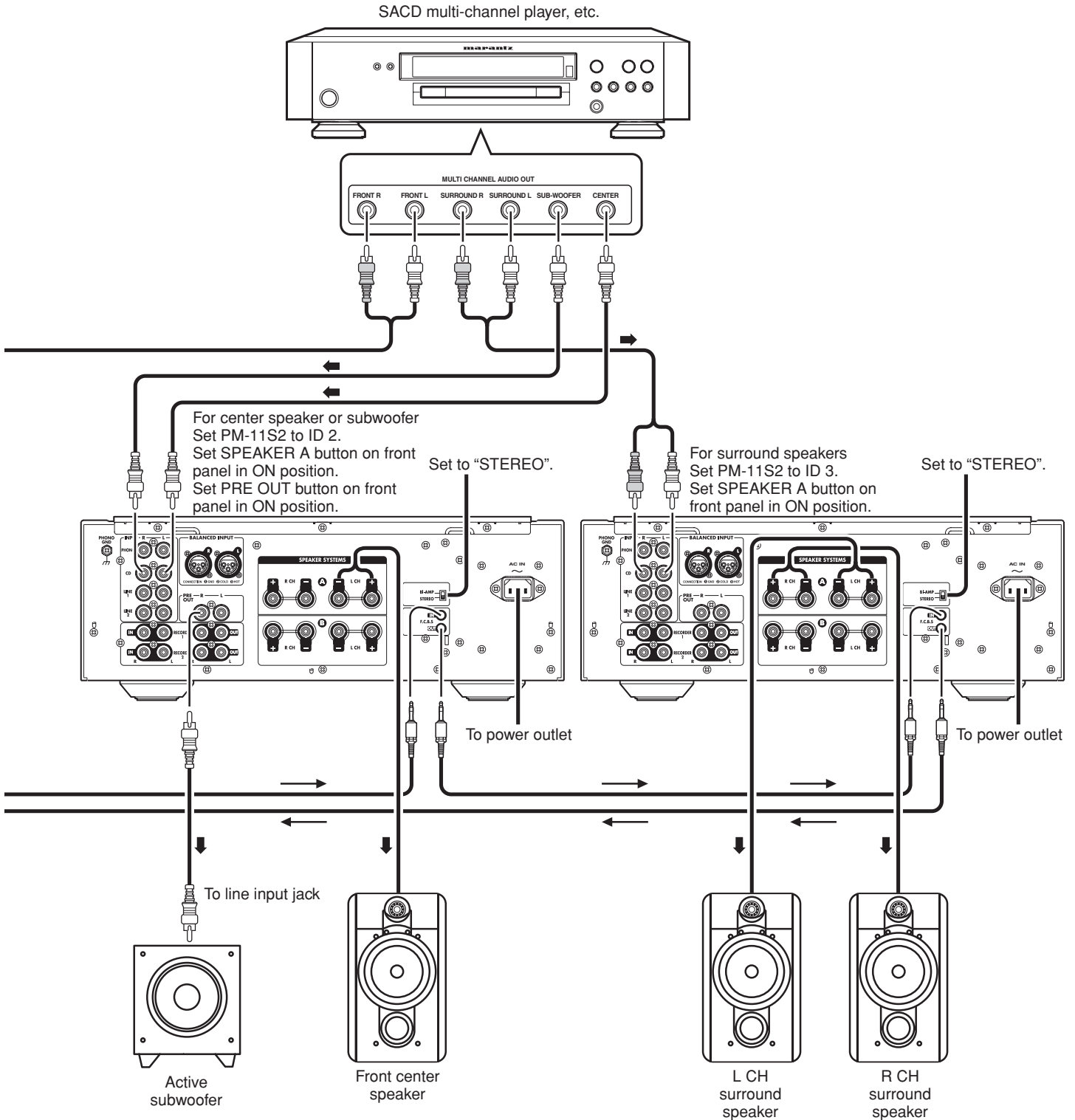

ADVANCED CONNECTIONS

F.C.B.S.

F.C.B.S. (Floating Control Bus System) is a communication system that connects up to four PM-11S2s over a dedicated bus line so as to enable synchronized operations amongst them via 2-way data communications.

Prepare the correct number of portable audio connection cables for the number of units to be connected. Either of the following types of connection cables are adequate.

- Monaural miniplug ⇔ monaural miniplug connecting cable

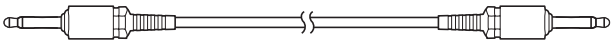

- Stereo miniplug ⇔ stereo miniplug connecting cable

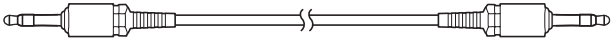

Note:

Do not use connecting cables that contain resistance.

The figure below shows an example of four PM-11S2s connected by F.C.B.S. The top unit is the master unit with ID 1 and controls the three slave units with ID 2~4. When the master unit is operated, the input source, volume level, ATT feature, display and tone control ON/OFF feature of the slave units are operated in sync with the master unit.

This function can be applied to various usages such as complete bi-amp with 2 PM-11S2s (page. 17), and 5.1ch multi-channel with 3 PM-11S2s (page. 19).

Note:

The PM-11S2 F.C.B.S. function is only valid between the same PM-11S2 models. This function may not operate correctly if other Marantz models (PM-11S1, PM-15S1 etc) are connected.

To turn the power of multiple F.C.B.S.-connected units ON/OFF, switch the power ON in order of lowest to highest ID number, and switch the power OFF in order of highest to lowest ID number.

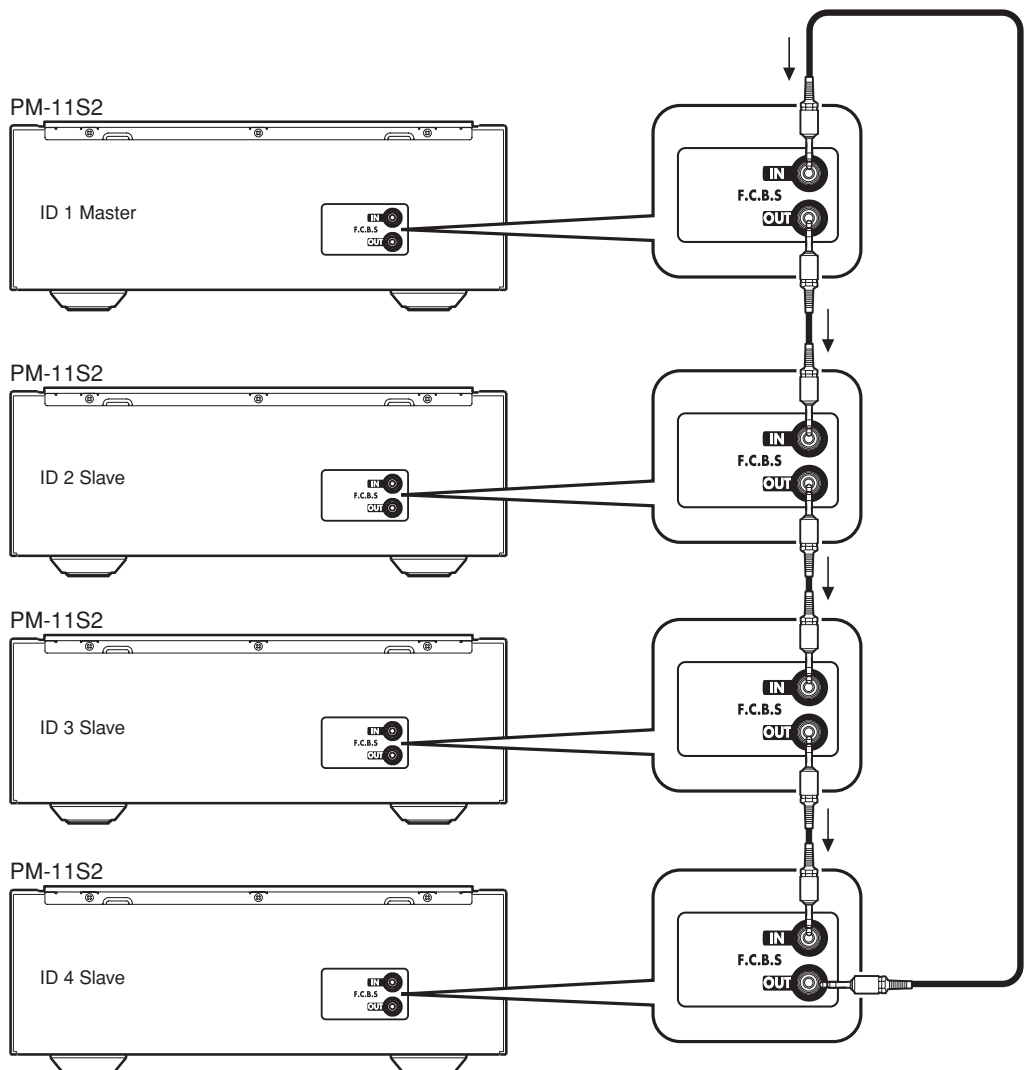

ADVANCED OPERATIONS

HOW TO SET ID NUMBERS

If using this unit by itself as a stereo amplifier, set the ID number to "0" (Default setting is "0").

Note:

If the ID number is set to a number other than "0", this unit cannot be used for standalone operation.

The ID number of the unit appears on the display for about 3 seconds after the power is activated.



When multiple PM-11S2s are connected, a unique ID number must be set of each one in order to distinguish between them.

The unit that centrally controls the other units takes ID 1. The unit with ID1 is called the "Master". The other units that synchronize with the master are called "slaves" and take IDs "2" ~ "4".

INPUT SELECTOR

Knob

DISPLAY button

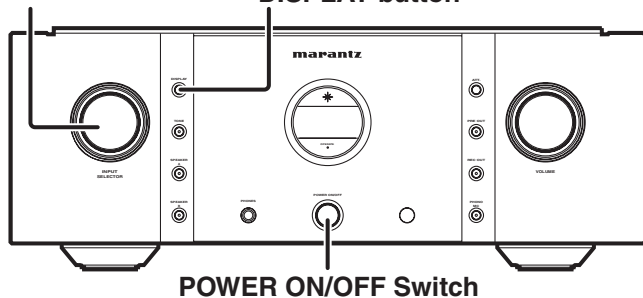

POWER ON/OFF Switch

Set ID numbers as follows.

1. While pressing and holding the DISPLAY button, press the POWER ON/OFF switch.



2. Turn the INPUT SELECTOR knob to the desired ID number.



After finishing setting the ID number, turn power to the unit OFF.

The setting is stored in memory and becomes active the next time power to the unit is switched ON.

BI-AMP MODE

This unit is equipped with a bi-amp mode to enable a complete bi-amp connection using two PM-11S2s. This complete bi-amp connection is a high-end technique for enhancing sound quality, proposed by Marantz. Using this system, the bi-amp supporting speaker system is separated from the preamplifiers that separately drive the low and high speakers. (For more information, see **STEREO COMPLETE BI-AMP CONNECTION** (page.17).)



The bi-amp mode is engaged by setting the operating mode switch on the rear panel to "BI-AMP". In the bi-amp mode, the signals input to the L channel are split by the input selector and sent to the left and right volume amplifiers, and are then output to the PRE OUT terminals. The figures below show example displays in the stereo and bi-amp modes.

Stereo mode

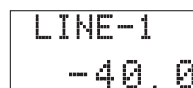

Bi-amp mode

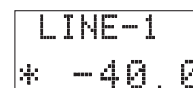

Notes:

- When in bi-amp mode, the R channel input jacks cannot be used.
- When in bi-amp mode, the signals input into the L channel are output from both channels. Therefore, the same signals are output from the L channel and R channel in RECORDER OUT, PRE OUT, PHONES OUT.
- Always turn the power to the unit OFF before changing the operating mode switch setting. Turning the power ON again activates the new setting.

ADVANCED OPERATIONS

TRIMMING

There are three trimming modes.

- LEVEL trimming that adjusts the volume level on left and right channels
- BASS trimming that adjusts the bass on left and right channels
- TREBLE trimming that adjusts the treble on left and right channels

Note:

Trimming is performed from the remote controller.

TRIM : This button starts trimming. When multiple PM-11S2s are connected, this button selects the amplifier with which to perform trimming. In such case, trimming is performed in the order of the lowest to highest ID number.

EXIT : This button ends trimming.

- ▲ : This button increases the trimming level.
- ▼ : This button decreases the trimming level.
- ▶ : This button selects the R channel for trimming.
- ◀ : This button selects the L channel for trimming.

ENTER : This button selects the trim mode (LEVEL, BASS or TREBLE).

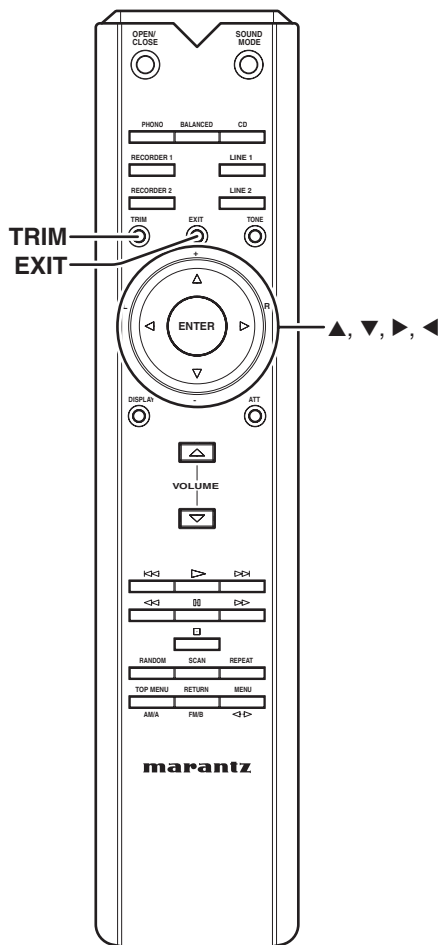

How to Trim Volume Level

The volume level of the left and right channels can be trimmed in 0.5dB steps across a 0.0 – 9.0dB range. When the unit is shipped from the factory, the volume level is set to 0.0dB (maximum).

1. Press the TRIM button once to access the LEVEL trimming mode.

```
L LEVEL R
  00  00
```

2. The flashing "0.0" on the left indicates that trimming is activated for the left channel volume level. Press the ▲ and ▼ buttons to set the volume level of the left channel.

```
L LEVEL R
-6.0  0.0
```

3. Press the ▶ button to set the right channel volume level. When the right side "0.0" starts flashing, trimming is activated for the right channel volume level. Press the ▲ and ▼ buttons to set the volume level of the right channel.

```
L LEVEL R
-6.0 -6.0
```

4. To trim the volume level of the ID 2 (slave) unit, press the TRIM button again and set the volume level as in steps 1~3. After that, pressing the TRIM button again allows you to trim the volume level for the "ID 3" unit and so forth.
5. When finished with volume level trimming, press the EXIT button.

ADVANCED OPERATIONS

■ How to Trim Bass

The bass level of the left and right channels can be trimmed in 2dB steps across a $-8.0 - +8.0$ dB range. When this unit is shipped from the factory, the bass level is set to 0 dB. To trim the bass level, active tone control by pressing the TONE button on either the unit or the remote controller.

1. Press the TRIM button once to access the LEVEL trimming mode.

```
L LEVEL R
  00  00
```

2. Press the ENTER button once to access the BASS trimming mode.

```
L BASS R
  0    0
```

3. The flashing "0" on the left indicates that trimming is activated for the left channel bass level. Press the ▲ and ▼ buttons to set the bass level of the left channel.

```
L BASS R
+6    0
```

4. Press the ► button to start the "0" on the right side flashing. When the right side "0" starts flashing, trimming is activated for the right channel bass level. Press the ▲ and ▼ buttons to set the bass level of the right channel.

```
L BASS R
+6    +6
```

5. To trim the bass level of the ID 2 (slave) unit, press the TRIM button again and set the bass level as in steps 2-4. After that, pressing the TRIM button again allows you to trim the bass level for the "ID 3" unit and so forth.
6. When finished with bass level trimming, press the EXIT button.

■ How to Trim Treble

The treble level of the left and right channels can be trimmed in 2dB steps across a $-8.0 - +8.0$ dB range. When this unit is shipped from the factory, the bass level is set to 0 dB. To trim the treble level, active tone control by pressing the TONE button on either the unit or the remote controller.

1. Press the TRIM button once to access the LEVEL trimming mode.

```
L LEVEL R
  00  00
```

2. Press the ENTER button twice to access the TREBLE trimming mode.

```
L TREBL R
  0    0
```

3. The flashing "0" on the left indicates that trimming is activated for the left channel treble level. Press the ▲ and ▼ buttons to set the treble level of the left channel.

```
L TREBL R
+6    0
```

4. Press the ► button to start the "0" on the right side flashing. When the right side "0" starts flashing, trimming is activated for the right channel treble level. Press the ▲ and ▼ buttons to set the treble level of the right channel.

```
L TREBL R
+6    +6
```

5. To trim the treble level of the ID 2 (slave) unit, press the TRIM button again and set the treble level as in steps 2-4. After that, pressing the TRIM button again allows you to trim the treble level for the "ID 3" unit and so forth.
6. When finished with treble level trimming, press the EXIT button.

ADVANCED OPERATIONS

ATT. (ATTENUATION)

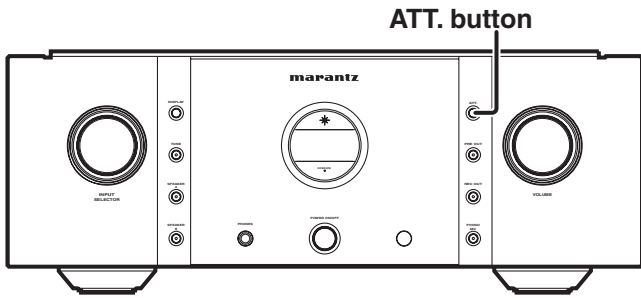

ATT is a one-touch feature for reducing the volume level. When the ATT button on either the unit or remote controller is pressed, the volume level is attenuated.

1. When the ATT button on either the unit or the remote controller is pressed, "ATT" flashes on the display and the volume level is reduced.

When the ATT button is pressed again or the volume is increased/decreased using the controls, the mode is canceled and the original volume level is restored.



2. When the ATT button is pressed with the volume level at $-\infty$ (muted), the display will change as it is shown below appears for about 3 seconds, and attenuation is not applied.

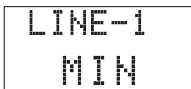

How to Set Attenuation Level

Attenuation level can only be set using the ATT button on the unit. The attenuation level can be set at -20dB , -40dB , or $-\infty$. The factory default setting is -20dB .

1. Press and hold the ATT button on the unit for 2 seconds or longer. The attenuation level will appear on the display.

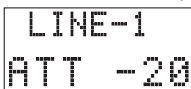

2. The attenuation level setting value changes with each press of the ATT button on the unit.
3. When the desired attenuation level setting appears on the display, leave it unchanged for 2 seconds or longer to enter the setting. Once entered, the display returns to the volume level indication.

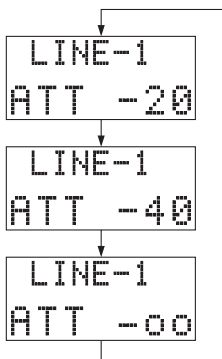

HOW TO OPERATE THE SIDE ILLUMINATION

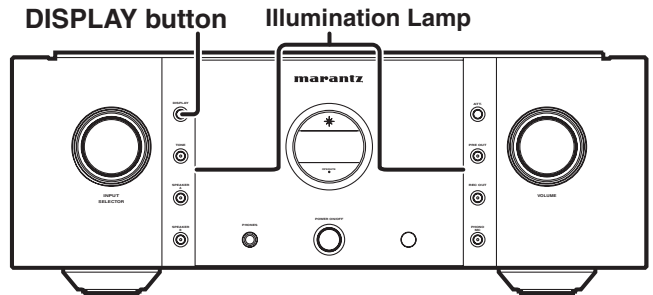

The illumination lamp has an always-ON mode (factory setting) and an always-OFF mode.

In the always-ON mode, the illumination lamp turns ON/OFF in sync with the display.

1. With the illumination lamp lit, press and hold the DISPLAY button for 3 seconds or longer. The illumination lamp goes out, and the always-OFF mode is engaged.
2. To cancel the always-OFF mode and turn the illumination lamp ON, press and hold the DISPLAY button for 3 seconds or longer.

TROUBLESHOOTING

■ Before considering it as a failure

In case of trouble with this component, first check the following before calling for service.

What seems to be a serious malfunction is often due to a simple operation mistake.

If the trouble is not fixed after making the following checks, contact the place of purchase, your nearest Marantz dealer, our customer service center, or our repair service center.

Phenomenon	Cause	Actions
Power is not supplied.	The power cord is disconnected.	Check the power cord connection.
	The protection circuit is activated.	If the OPERATE indicator is flashing, turn the power OFF then back ON again after 1 minute or more.
Power is supplied, but no sound is heard from the speakers.	Speaker connection is incomplete.	Check the speaker cable connection.
	Input cable connection is incomplete.	Check the input cable connection.
	Use of the connected player is wrong.	Confirm the operation methods, referring to the instruction manual of the player.
	The INPUT SELECTOR knob is not set correctly.	Set the INPUT SELECTOR knob properly.
	The VOLUME knob is set to minimum.	Turn the VOLUME knob to set the proper level.
	The SPEAKER buttons are set to OFF.	Set the SPEAKER A/B buttons properly, according to the SPEAKER terminals to which the speakers are connected.
	The ATT. muting function is activated.	If "ATT" is displayed on the display, press the ATT. button on the main unit or remote control unit, or increase/decrease the volume level, in order to cancel the attenuation function.
	The protection circuit has been activated, and the volume has been automatically muted.	Adjust the volume again.
Sound is heard from the left or right speakers only. Or, the volume from the right and left speakers differs.	An error message is displayed.	Set the ID number properly, referring to the table in "ERROR MESSAGES", on page 26.
	Speaker connection is incomplete.	Check the speaker cable connection.
Left and right channels are reversed.	The set values for the volume (LEVEL TRIM) and sound quality (BASS/TREBLE) adjustments for the left and right channels are different.	Perform trimming again.
	Connection of left and right speaker cables or input cables is reversed.	Make connections properly.
Sound is monaural.	The MODE switch on the rear panel is set to "BI-AMP".	Turn the unit off, set the MODE switch to STEREO, then turn the unit back on.
Noise occurs during record playing. Or, no sound is heard.	Grounding connection from the record player is improper.	Check the connections to the PHONO GND terminal.
	Connection to the PHONO input jacks is incomplete.	Check the PHONO input terminal connection.
	A TV set, etc. placed too close to the record player may affect the sound.	Place the TV set or record player in another position.
	The PHONO MC button on the front panel is not set properly for the cartridge used.	Set the PHONO MC button properly.
Howling occurs when sound volume is increased during record playing.	The record player and speakers are placed too close.	Place the speakers as far away from the record player as possible.
	The record player is placed on a rack or floor prone to vibration.	If an insulating pad is not supplied with the record player, use an insulating pad available on the market.

TROUBLESHOOTING

■ About the protection circuit

This unit is equipped with a protection circuit to protect the amplifier circuits and speaker system from damage.

If the protection circuit is activated, the sound is instantly muted. In this case, the message "PROTECT" flashes on the display panel, and the OPERATE indicator also flashes.

To deactivate the protection circuit, turn the unit off then back on again after about 1 minute or more.

● At power on

For about 8 seconds after the power is turned on, the protection circuit is activated, muting the sound to give the amplifier circuits time to stabilize. Once the amplifier circuits stabilize, the protection circuit is released, and audio is enabled.

● In the event of overcurrent

The protection circuit is activated if current exceeding a certain level is detected, which can happen if excessive signal flow is input to the amplifier or if the unit is connected to a speaker system of less than 4 Ω impedance. The protection circuit is also activated if a speaker cable shorts.

In such cases, the message "PROTECT" flashes on the display, and the volume is automatically reduced. After approximately 8 seconds, the protection circuit is released. Therefore, the volume needs readjusting to continue normal use.

If the overcurrent continues, the amplifier shuts itself OFF, and the OPERATE indicator flashes.

To deactivate the protection circuit, turn the unit off then back on again after about 1 minute or more.

● If excessive ultrabass signals are input

The protection circuit is also activated if ultrabass signals are input. In such a case, the OPERATE indicator flashes, and the volume is automatically reduced. After approximately 8 seconds, the protection circuit is released. Therefore, the volume needs readjusting to continue normal use. If excessive ultrabass signal input continues or if DC voltage is detected owing to trouble with the amplifier, the amplifier shuts itself OFF, and the OPERATE indicator flashes.

To deactivate the protection circuit, turn the unit off then back on again after about 1 minute or more.

● If the main-amplifier overheats

The protection circuit is activated if the temperature of the main-amplifier section rises above a certain level, which can happen if the amplifier is continuously used with excessive signal flow being input to it. The protection circuit is also activated when the specified operating temperature is exceeded, which can happen if the vents on top of the amplifier are covered or if the amplifier is installed on a cramped audio rack. In such a case, the OPERATE indicator flashes, and the volume is automatically reduced. After approximately 8 seconds, the protection circuit is released. Therefore, the volume needs readjusting to continue normal use.

If the temperature does not sufficiently fall within a certain amount of time after the protection circuit activation, the amplifier shuts itself OFF, and the OPERATE indicator flashes.

To deactivate the protection circuit, turn the unit off, let it stand until it cools down, then turn it ON again.

● In the event of amplifier trouble

The protection circuit is activated, and the power is automatically shut OFF, if an abnormality is detected in the power circuit. The same happens if the main fuse inside the amplifier blows. In such cases, the OPERATE indicator flashes.

Turn the unit off then after several minutes turn it on again. If the display does not light up, and the OPERATE indicator remains flashing after the unit is turned on again, the unit may be in failure.

■ Error messages

When multiple amplifiers are connected by F.C.B.S., the error messages described in the table below may be displayed on the display. In such a case, ID number setting or remote cable connection may be in failure. Check the ID number or remote cable connection, referring to the table below. For details on ID number setting, see "HOW TO SET ID NUMBERS", on page 21.

	Indication	Meaning	Measures to be taken
1	ERROR 02	Multiple amplifiers take ID No. 2.	Assign different ID numbers to the amplifiers.
2	ERROR 03	Multiple amplifiers take ID No. 3.	
3	ERROR 04	Multiple amplifiers take ID No. 4.	
4	ERROR 11	The amplifiers with ID Nos. 2-4 cannot communicate with the amplifier with ID No. 1.	If the amplifier with ID No. 1 is not on, turn it ON. Check that the remote cable is properly connected.
5	ERROR 12	The amplifier with ID No. 1 cannot communicate with the amplifiers with ID Nos. 2-4.	If multiple amplifiers take ID No. 1, set ID numbers properly. Check that the remote cable is properly connected.

OTHERS

SPECIFICATIONS & DIMENSIONAL DRAWINGS

- Power output
(20 Hz – 20 kHz simultaneous drive of both channels)
 -100W x 2 (8Ω load)
 -200W x 2 (4Ω load)
- Total frequency distortion
(20Hz – 20kHz simultaneous drive of both channels, 8Ω load)
 -0.01%
- Output band width (8Ω load, 0.05%) 5Hz ~50kHz
- Frequency response (CD, 1W, 8Ω load) ..5Hz ~ 120kHz±3dB
- Dumping factor (8Ω load, 20Hz – 20kHz)..... 100
- Input sensitivity/Input impedance
 - PHONO (MC).....270μV/100Ω
 - PHONO (MM)3mV/47kΩ
 - BALANCED480mV/20kΩ
 - CD/LINE.....240mV/20kΩ
- Output voltage/Output impedance
 - PRE OUT 1.9 V/220Ω
- Maximum allowed PHONO input (1kHz)
 - MC 12mV
 - MM..... 130mV
 - RIAA deviation (20Hz ~ 20kHz) ±0.5dB
- S/N (IHF-A, 1W, 8Ω load)
 - PHONO (MC).....76dB (0.5mV input)
 - PHONO (MM)90dB (5mV input)
 - BALANCED95dB (1V input)
 - CD/LINE.....96dB (500mV input)
- Tone control
 - Bass (50Hz) ±8dB
 - Treble (20kHz)..... ±8dB
- Power requirement
 -AC 120V 60Hz (U.S.A.)
 - AC 230V 50/60Hz (Europe)
- Power consumption
 - (EN60065 7th Ed.) 300W
 - (UL60065)..... 300W
- Accessories
 - Remote controller 1
 - AAA batteries2
 - Detachable AC power cable..... 1
- Maximum outer dimensions (Amp)
 - Width..... 17-3/8 ins. (440 mm)
 - Height6-5/8 ins. (168 mm)
 - Depth 17-1/2 ins. (444 mm)
- Weight (Amp)..... 58.6 lbs (26.6 kg)

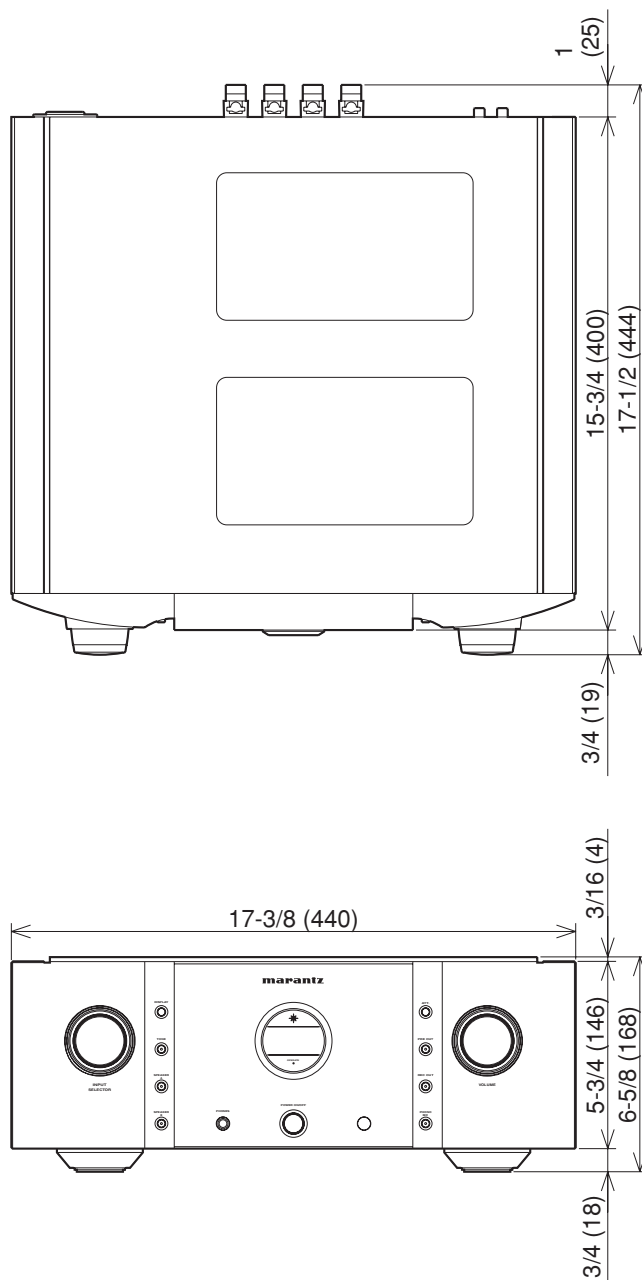

Unit: inch (mm)

Specifications subject to change without prior notice.

OTHERS

■ Cleaning of equipment external surfaces

The exterior finish of your unit will last indefinitely with proper care and cleaning. Never use scouring pads, steel wool, scouring powders or harsh chemical agents (e.g., lye solution), alcohol, thinner, benzine, insecticide or other volatile substances as these will mar the finish of the equipment. Likewise, never use cloths containing chemical substances. If the equipment get dirty, wipe the external surfaces with a soft, lint-free cloth.

If the equipment becomes heavily soiled:

- dilute some washing up liquid in water, in a ratio of one part detergent to six parts water.
- dip a soft, lint free in the solution and wring the it is damp.
- wipe the equipment with the damp cloth.
- dry the equipment by wiping it with a dry cloth.

**■ Using headphones**

If the volume in the headphones is too high, it may injure your ears. Do not set the sound volume too high.

■ Repairs

Only the most competent and qualified service technicians should be allowed to service the factory-trained warranty station personnel have the knowledge and special facilities needed for repair and calibration of this precision equipment. After the warranty period has expired, repairs will be performed for a charge if the equipment can be returned to normal operation.

In the event of difficulty, refer to your dealer or write directly to the nearest location to you that is listed on the Marantz Authorized Service Station list. If writing, please include the model and serial number of the equipment together with a full description of what you think is abnormal about the equipment's behaviour.

www.marantz.com

You can find your nearest authorized distributor or dealer on our website.

marantz[®] is a registered trademark.

